

TECHNICAL MANUAL

**OPERATOR'S, ORGANIZATIONAL, DIRECT SUPPORT,
AND GENERAL SUPPORT MAINTENANCE MANUAL**

DIFFERENTIAL COMPARATOR

TEKTRONIX TYPE 3A7

This is a reprint
including Change 1.

NOTE

This manual is an authentication of the manufacturer's commercial literature which, through usage, has been found to cover the data required to operate and maintain this equipment. Since the manual was not prepared in accordance with military specifications, the format has not been structured to consider level of maintenance nor to include a formal section on depot overhaul standards.

This manual contains copyrighted information, reproduced by permission of Tektronix, Inc. All rights reserved.

Change

No. 2

HEADQUARTERS
DEPARTMENT OF THE ARMY
WASHINGTON, DC, 11 April 1986

**OPERATOR'S, ORGANIZATIONAL, DIRECT SUPPORT
AND GENERAL SUPPORT MAINTENANCE MANUAL,
INCLUDING REPAIR PARTS AND SPECIAL TOOLS LIST:
DIFFERENTIAL COMPARATOR,
TEKTRONIX TYPE 3A7
(NSN 6625-00-228-7845)**

Current as of 11 April 1986

TM 9-6625-1897-14-1, 15 June 1972, is changed as follows:

1. Remove old pages and insert new pages as indicated below. New or changed material is indicated by a vertical bar in the margin of the page.

Remove pages	Insert pages
i	i
10-1 through 10-3	

2. File this change sheet in front of the publication for reference purposes.

By Order of the Secretary of the Army:

JOHN A. WICKHAM, JR.
General, United States Army
Chief of Staff

Official:

R. L. DILWORTH
Brigadier General, United States Army
The Adjutant General

Distribution:

To be distributed in accordance with DA Form 12-34C, Block No. 319, requirements for calibration procedures publications.

Change }
No. 1 }

HEADQUARTERS
DEPARTMENT OF THE ARMY
WASHINGTON, DC 1 April 1975

**OPERATOR'S ORGANIZATIONAL, DIRECT SUPPORT,
AND GENERAL SUPPORT MAINTENANCE
MANUAL, INCLUDING REPAIR PARTS AND
SPECIAL TOOLS LIST:
DIFFERENTIAL COMPARATOR,
TEKTRONIX TYPE 3A7
(NSN 6625-00-228-7845)**

Current as of 11 September 1974

TM 9-6625-1897-14-1, 15 June 1972, is changed a follows:

1. The title is changed to read as shown above.
2. Remove old pages and insert new pages as indicated below. New or changed material is indicated by a vertical bar in the margin of the page.

Remove pages
i

Insert pages
i
10-1 through 10-3

3. File this change sheet in front of the publication for reference purposes.

By Order of the Secretary of the Army:

Official:

FRED C. WEYAND
General, United States Army
Chief of Staff

VERNE L. BOWERS
Major General, United States Army
The Adjutant General

Distribution:

To be distributed in accordance with DA Form 12-34, Section II, (qty rqr block No. 75) requirements for Calibration Procedures Publications.

Technical Manual }
 No. 9-6625-1897-14-1 }

HEADQUARTERS
 DEPARTMENT OF THE ARMY
 Washington, D.C., 15 June 1972

**OPERATOR'S, ORGANIZATIONAL, DIRECT SUPPORT, AND
 GENERAL SUPPORT MAINTENANCE MANUAL INCLUDING
 REPAIR PARTS AND SPECIAL TOOLS LIST
 DIFFERENTIAL COMPARATOR,
 TEKTRONIX TYPE 3A7
 (NSN 6625-00-228-7845)**

Section	<i>Page</i>
0. INTRODUCTION	0-1
1. CHARACTERISTICS	1-1
2. OPERATING INSTRUCTIONS	2-1
3. CIRCUIT DESCRIPTION.....	3-1
4. MAINTENANCE.....	4-1
5. MAINTENANCE CALIBRATION	5-1
6. ELECTRICAL PARTS LIST.....	6-1
7. MECHANICAL PARTS LIST.....	7-1
8. DIAGRAMS	8-1
9. PREVENTIVE MAINTENANCE INSTRUCTIONS.....	9-1
10. (Deleted).....	10-1
APPENDIX A. REFERENCES.....	A-1
B. BASIC ISSUE ITEMS LIST AND ITEMS TROOP INSTALLED OR AUTHORIZED LIST (Not Applicable).....	B-1
C. MAINTENANCE ALLOCATION CHART.....	C-1
10. REPAIR PARTS LIST.....	10-1

☆ U.S. GOVERNMENT PRINTING OFFICE 1986--635-395/20184 REGION #4

SECTION 0 INTRODUCTION

Scope

This manual includes installation and operation instructions and covers operators, organizational, direct support (DS), and general support (GS) maintenance. It describes Differential Comparator, Tektronix Type 3A7.

The basic issue items list is not applicable.

Indexes of Publications

DA Pam 310-4. Refer to the latest issue of DA Pam 310-4 to determine if there are any new editions, changes, or additional publications pertaining to the equipment.

DA Pam 310-7. Refer to DA Pam 310-7 to determine whether there are modification work orders (MWO) pertaining to the equipment.

Forms and Records

Reports of Maintenance and Unsatisfactory Equipment. Use equipment forms and records in accordance with instructions given in TM 38-750.

Report of Packaging and Handling Deficiencies. Fill out and forward DD Form 6, Report of Packaging and Handling Deficiencies, as prescribed in AR 700-58 (Army), NAVSUP Pub 378 (Navy), AFR 71-41 (Air Force), and MCO P4030.29 (Marine Corps).

Discrepancy in Shipment Report. Fill out and forward SF 361, Discrepancy in Shipment Report (DISREP), as prescribed in AR 55-38 (Army), NAVSUP Pub 459 (Navy), AFM 75-34 (Air Force), and MCO P4610.19 (Marine Corps).

Reporting of Equipment Publication Improvements. The reporting of errors, omissions, and recommendations for improving this publication by the individual user is encouraged. Reports should be submitted on DA Form 2028 (Recommended Changes to Publications) and forwarded direct to: Commanding General, U. S. Army Missile Command, ATTN: AMSMI-MFM, Redstone Arsenal, AL 35809.

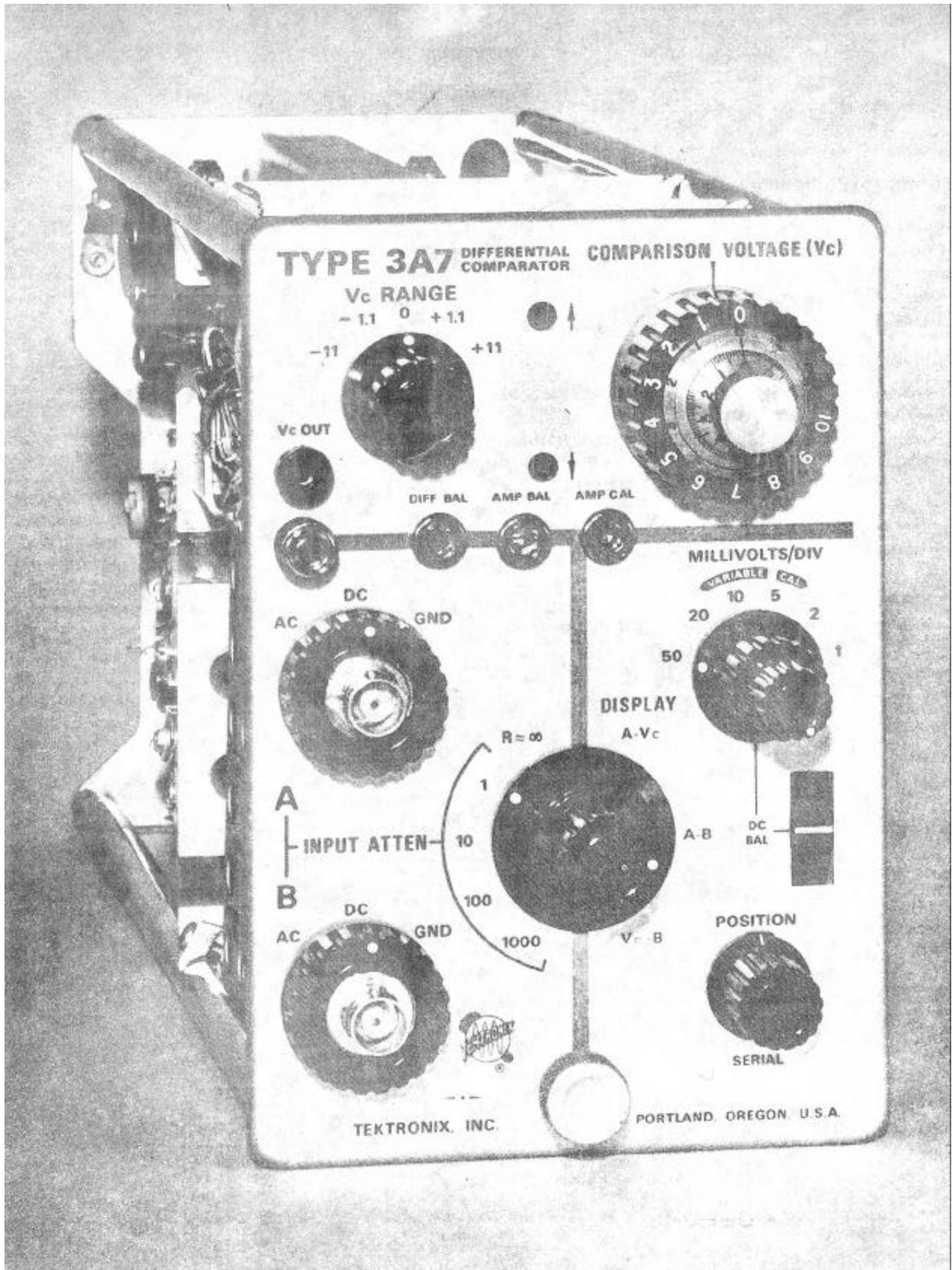

Fig. 1-1. The Type 3A7 Differential Amplifier.

SECTION 1 CHARACTERISTICS

General Information

The Type 3A7 Differential Comparator plug-in unit is designed for use with all 560-Series oscilloscopes (except the Type 560 itself) and their rackmount equivalents. The unit can also be used in conjunction with a Type 129 Plug-In Power Supply.

The primary operating modes for the unit are: (1) conventional amplifier, (2) differential amplifier, or (3) calibrated differential comparator.

As a conventional amplifier, two switches select the calibrated deflection factors from 1 mV/div to 50 V/div. The MILLIVOLTS/DIV switch changes the amplifier gain in a 1-2-5 sequence from 1 mV/div to 50 mV/div. The input attenuator switch provides decade attenuation from 1X to 1000X. Bandpass is greater than 10MHz at a deflection factor of 50 mV/div; at 1 mV/div bandpass is greater than 4 MHz.

As a differential amplifier, common-mode rejection ratio (CMRR) exceeds 20,000:1 from dc to 20 kHz and 500:1 at 500 kHz. CMRR is defined as the ratio of common-mode input voltage to differential output voltage. Differential output voltage is the indicated voltage on the screen (vertical deflection X mV/div setting). A ratio of better than 20,000:1 at dc and low frequencies allows measurement of signals less than 1 mV in amplitude on ±11-volt common-mode signals.

As a calibrated differential comparator, the slideback technique is used to make precise voltage measurements. The internal highly-accurate ±11-volt comparison voltage (Vc) is applied differentially to the Type 3A7 input stage. With a dynamic range of ±11 volts and a maximum sensitivity of 1 mV/div, the effective screen height is ±11,000 div (11V ÷ 1 mV). Measurement readout resolution is 100 μV/mm or 0.001% (100 μV ÷ 11V).

AS A CONVENTIONAL AMPLIFIER

Deflection Factor

The MILLIVOLTS/DIV switch has six calibrated positions: 1, 2, 5, 10, 20 and 50 mV/div. A variable (uncalibrated) control provides continuously-variable adjustment between steps and up 125 mV/div for the last step. A decade attenuator extends the calibrated deflection factor range to 50 V/div.

Calibration Accuracy

An adjustment is provided to set the gain of the amplifier. When this adjustment is accurately set with the MILLIVOLTS/DIV switch in the 1 mV/div position, the deflection factor for any other position of the switch will be within ±3%.

Approximate Input Characteristics

For the 1, 10, 100 and 1000 positions of the INPUT ATTEN switch, the input impedance is approximately 1 megohm paralleled by 20 pF (nominal). The 1X input

resistance matches the 10X input attenuator resistance within ±0.1%.

For the R ≈ ∞ position, input resistance is on the order of 10,000 to 50,000 megohms paralleled by about 20 pF.

Bandpass and Risetime

See Table 1-1

TABLE 1-1
Bandpass and Risetime
(Source impedance: 25 ohms)

MILLIVOLTS/DIV Switch Position	Bandpass in MHz/Sec ¹ (dc to 30%-down point)	Risetime ²
50	≥10MHz	≤35 nsec
20	≥10MHz	≤35 nsec
10	≥10 MHz	≤35 nsec
5	≥8 MHz	≤43.8 nsec
2	≥6 MHz	≤58.3 nsec
1	≥4 MHz	≤87.6 nsec

¹Bandpass in megahertz for signals that are dc coupled and do not overscan the screen. Using ac coupling the low-frequency 30%-down point is 1/2 Hz; the high-frequency 30%-down point is the same as given in the table.

²Calculated from high-frequency 30 %-down point using this formula:

$$\text{Risetime} = \frac{0.35}{\text{Frequency}}$$

Input Attenuation Accuracy

See Table 1-2.

TABLE 1-2

INPUT ATTEN Switch Position	Attenuation Accuracy
10	± 0.05%
100	± 0.15%
1000	± 3%

Maximum Allowable Input Voltage Rating

See Table 1-3.

TABLE 1-3
Maximum Input Voltage

INPUT ATTEN Switch Position	Combined DC and Peak AC (DC coupled)	Peak AC (AC coupled)
R ≈ ∞ and 1	±15V	15V
10	±150V	150V
100 and 1000	±500V	500V

Characteristics-Type 3A7

Input Crosstalk

≤5%. Measured when driven grid is dc coupled, deflection factor is 5 mV/div, and 300-mV peak-to-peak 50 kHz sine waves are used as the drive signal. Undriven grid is switched to DC. DISPLAY switch is set to Vc-B when signal is applied to input A. Amplitude of feed-through signal is then measured and expressed as a percentage of the applied signal. Next, the signal is applied to input B, the DISPLAY switch is set to A-Vc and the measurement is repeated.

AS A DIFFERENTIAL AMPLIFIER

Maximum Common-Mode Signal Amplitude

Refer to Table 1-3.

Common-Mode-Rejection Ratio

See Table 1-4.

TABLE 1-4

Common-Mode Signal	Method of Coupling	Minimum Common-Mode Rejection Ratio
DC ¹	DC	20,000:1
20 kHz ²	DC	20,000:1
500 kHz ²	DC	500:1
60 Hz ¹	AC	1,000:1

¹DC common-mode rejection ratio (CMRR) is measured with the Type 3A7 set for 1 mV/div sensitivity. First, both AC-DC-GND switches are set to GND, the DISPLAY switch is set to A-B and the trace is centered. The comparison voltage is then set to ± 10 V and applied to both inputs. Both AC-DC-GND switches are set to DC. The indicated voltage (trace shift times MILLIVOLTS/DIV switch position) is then measured. Rejection ratio is the applied voltage divided by indicated voltage. The measurement is repeated when -10 V is applied.

²Signal amplitude of 30 volts peak to peak is dc coupled to both inputs. The Type 3A7 sensitivity is set to 1 mV/div and the mode is A-B. CMRR is the peak-to-peak input signal amplitude divided by the peak-to-peak display amplitude.

³Signal amplitude of 30 volts peak to peak is ac coupled to both inputs. CMRR is then measured the same as described for footnote ².

AS A CALIBRATED DIFFERENTIAL COMPARATOR

Comparison Voltages

Two voltage ranges are provided: from zero to ±1.1 volt, and from zero to ±11 volts. The Vc RANGE switch selects the range, a second switch selects the first digit and a precision 10-turn potentiometer selects the remaining digits.

Comparison Voltage Accuracy and Drift

Within ±0.15% of indicated voltage plus ±0.05% of full Vc range.

Readout Resolution

100 μV/mm at maximum sensitivity.

Maximum Input Grid Current

2 nanoamperes maximum; typically less than 1 nanoampere.

Overdrive Recovery

Application of an input signal of sufficient amplitude to drive the trace off the screen may overdrive the Type 3A7 amplifier.

If overdriven by a 10-volt step signal, the amplifier will recover within 10 mV of the final signal value in 300 nsec. Certain overdrive signals may cause an additional slow (thermal) shift in the reference level of ≤5 mV.

Input Attenuation Accuracy

Attenuation accuracy is within the tolerance specified in Table 1-2.

Environment

- Storage: -40°C to +65°C, 50,000 ft.
- Operating Temperature: 0°C to +50°C.
- Operating Altitude: To 15,000 ft.

OTHER CHARACTERISTICS

Mechanical Specifications

- Construction: Aluminum-alloy chassis.
- Front Panel: Anodized.

Accessories Supplied

Information on accessories for use with this instrument is included at the rear of the mechanical parts list.

SECTION 2 OPERATING INSTRUCTIONS

Front Panel

A front-panel view of the Type 3A7 is shown in Fig. 2-1. A brief functional description of the front-panel controls, connectors, indicator lights and securing latch is included.

Preliminary Operation

The Type 3A7 can be used in either the X-axis or Y-axis plug-in opening of a Tektronix Type 561, 561A, 564, 565 or 567 Oscilloscope or their rackmount equivalents. Assume for this manual that the Type 3A7 is inserted in the left-hand (Y-axis) opening to provide vertical deflection of the crt beam.

NOTE

To provide the best possible turn-on conditions for the unit, insert the unit in the oscilloscope when the oscilloscope power is off.

For preliminary operation this procedure is suggested:

1. After inserting the unit into the oscilloscope plug-in compartment, set the oscilloscope Intensity control fully counterclockwise and turn on the oscilloscope power.

2. Set the Type 3A7 front-panel controls as follows:

Vc RANGE	0
COMPARISON VOLTAGE	0-0-0
AC-DC-GND (both inputs)	GND
INPUT ATTEN	1
DISPLAY	A-B
MILLIVOLTS/DIV	50
VARIABLE	CAL
POSITION	Midrange

3. Set the oscilloscope Time/Div switch to .5 msec, the Intensity control to a normal intensity position and the triggering controls to obtain a free-running sweep.

4. Wait at least 15 minutes for the oscilloscope and plug-in to warm up and stabilize.

5. Check the DC BAL and AMP BAL adjustments by performing the procedures which follow.

Front-Panel Adjustments

After the Type 3A7 has warmed up and stabilized, check its operation to see if one or more of the following adjustments needs to be made. In the DC Balance and Amplifier Balance procedures that follow, the procedures assume the Type 3A7 is being used for the first time. Once these adjustments are made, the DC BAL is the only adjustment that needs occasional "touching up" during normal use of the unit.

1. DC Balance

With the AC-DC-GND switches set to GND, any vertical shift of the trace as the VARIABLE control is rotated indicates

need for adjusting the DC BAL control (see Fig. 2-1). To make this adjustment, proceed as follows:

a. First, set the front-panel controls to the some positions as listed in the Preliminary Operation procedure given earlier.

b. Adjust the DC BAL control to eliminate any vertical shift of the trace as the VARIABLE control is rotated back and forth.

c. Set the MILLIVOLTS/DIV switch to 5. If the trace moves off the crt, adjust the AMP BAL control (see Fig. 2-1) to position the trace near the center of the crt.

d. Repeat step 1b.

e. Set the MILLIVOLTS/DIV switch to 1. If the trace is off the crt, adjust the AMP BAL control to position the trace near graticule center.

f. Repeat step 1b. While repeating step 1b, keep the trace centered on the crt by adjusting the AMP BAL control.

IMPORTANT

Once the DC BAL and AMP BAL (next step) controls are initially adjusted, only the DC BAL control need be adjusted occasionally to minimize trace shift as either the VARIABLE or MILLIVOLTS/DIV control is rotated. This also applies when the Type 3A7 is transferred from one oscilloscope to another.

2. Amplifier Balance

If the trace shifts as the MILLIVOLTS/DIV switch is moved from one position to the next through all its positions, this indicates that the AMP BAL adjustment needs to be checked. Since this adjustment interacts with the DC BAL control, perform step 1 DC Balance procedure first if you have not already done so. Leave the controls as they are upon completing step 1 and then proceed as follows:

a. Set the MILLIVOLTS/DIV switch to 50. Using the POSITION control, position the trace to graticule center.

b. Set the MILLIVOLTS/DIV switch to 1 and adjust the AMP BAL control so the trace is positioned to graticule center.

c. Repeat step 1b in the Dc Balance procedure and steps 2a and 2b in this procedure as often as necessary to minimize trace shift as the VARIABLE and MILLIVOLTS/DIV controls are rotated.

NOTE

Once the AMP BAL control is adjusted as desired, it ordinarily does not require readjustment. Any trace shift that results from rotating the VARIABLE or MILLIVOLTS/DIV controls during normal use of the Type 3A7 can be minimized by adjusting the DC BAL control.

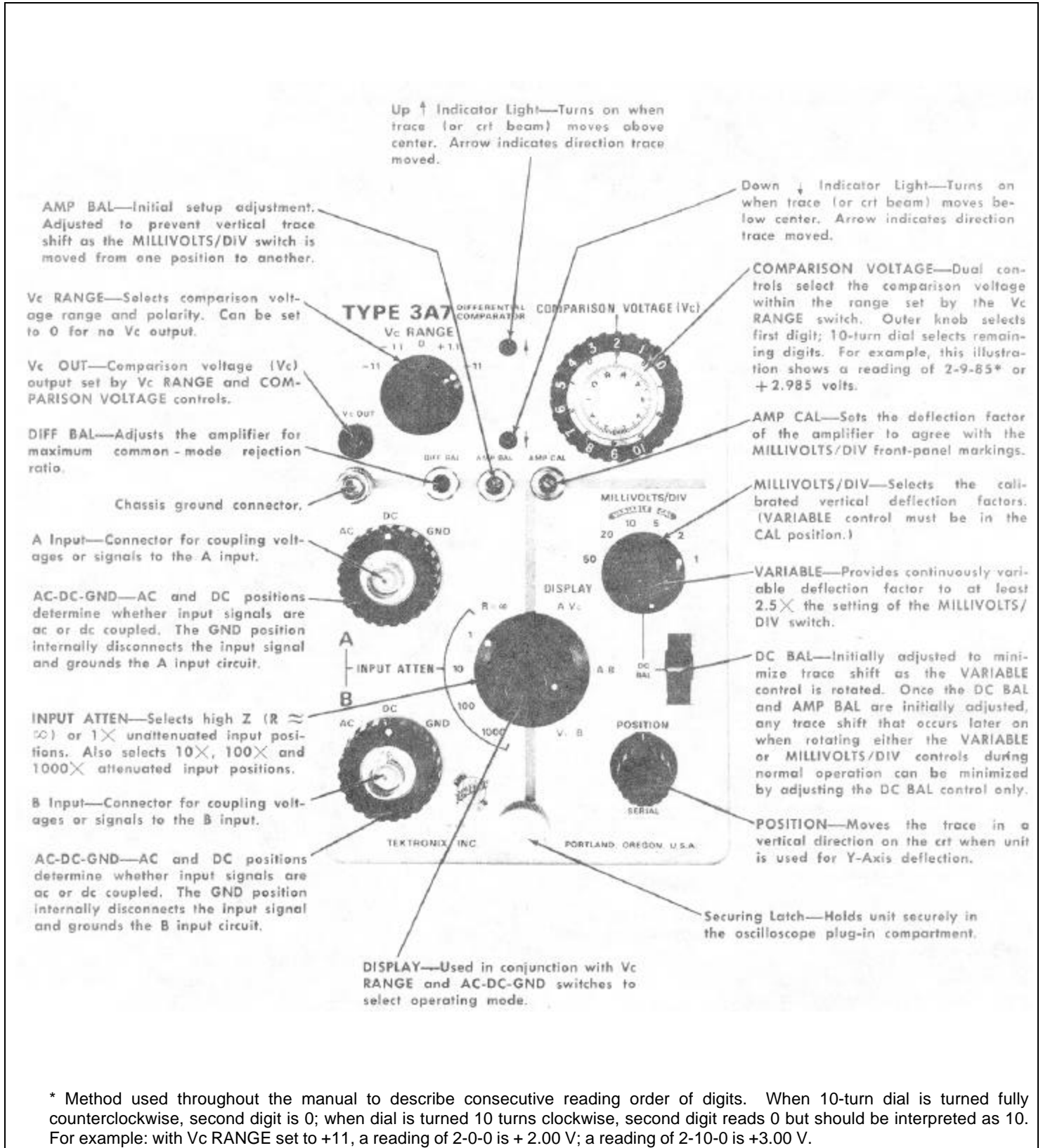

* Method used throughout the manual to describe consecutive reading order of digits. When 10-turn dial is turned fully counterclockwise, second digit is 0; when dial is turned 10 turns clockwise, second digit reads 0 but should be interpreted as 10. For example: with Vc RANGE set to +11, a reading of 2-0-0 is +2.00 V; a reading of 2-10-0 is +3.00 V.

Fig. 2-1. Function of front-panel controls, connector, indicator lights and securing latch.

Operating Instruction-Type 3A7

3. Amplifier Gain Calibration

The AMP CAL adjustment (see Fig. 2-1) should be checked periodically to assure correct vertical deflection factors. The adjustment can be made using the oscilloscope calibrator as the signal source. If greater accuracy is desired, a signal source with greater amplitude accuracy should be used.

a. Set the front-panel controls as follows:

AC-DC-GND (A)	DC
AC-DC-GND (B)	GND
INPUT ATTEN	1
DISPLAY	A-B
MILLIVOLTS/DIV	1
VARIABLE	CAL

b. Apply a 5 mV peak-to-peak calibrator signal through a coaxial cable to the A input connector.

c. Using the POSITION control, position the display to the center of the crt viewing area. Set the time-base controls to display several cycles of the waveform.

d. Adjust the AMP CAL control to obtain exactly 5 div of vertical deflection (see Fig. 2-2).

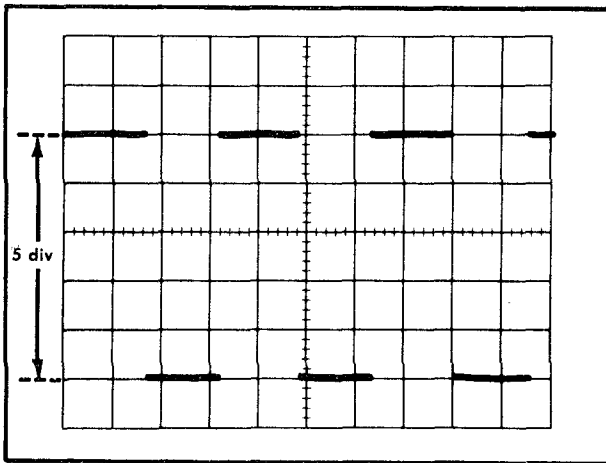

Fig. 2-2. Adjusting the AMP CAL control for proper deflection.

4. Differential Balance

Differential balance may be quickly checked using the following procedure:

a. Set the front-panel controls as follows:

AC-DC-GND (A and B)	DC
INPUT ATTEN	1
DISPLAY	A-B
MILLIVOLTS/DIV	1
VARIABLE	CAL
POSITION	Midrange

b. Apply 10 volts of calibrator signal through a coaxial cable and a dual-input connector (having matched length signal paths) to both A and B connectors.

c. Set the oscilloscope Time/Div switch to display several cycles of the waveform.

d. Ignoring the positive and negative-going spikes, adjust the DIFF BAL control (see Fig. 2-1) to eliminate any square-wave response; that is to obtain a minimum amplitude display similar to the waveform shown in Fig. 2-3.

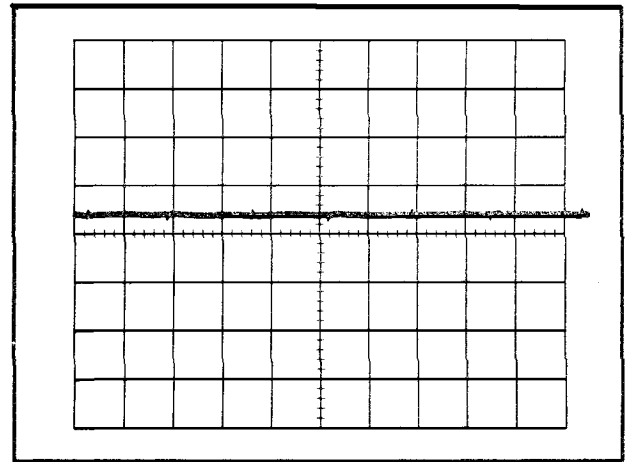

Fig. 2-3. Adjusting the DIFF BAL control to obtain a minimum amplitude display.

Drift

At a maximum sensitivity of 1 mV/div, drift with time is normally 1 mV or less per hour when averaged over an 8-hour period with ambient temperature and line voltage held constant. Drift with temperature is less than 1 mV per degree Celsius (centigrade).

The following conditions will minimize drift:

1. Side and bottom panels are installed on the oscilloscope.
2. Line voltage variations are small.
3. Thermal environment is constant.
4. Sufficient time is allowed for the Type 3A7 and oscilloscope to warm up.
5. Shock and excessive vibration forces are avoided.

Block Diagram

The simplified block diagram shown in Fig. 2-4 is useful for studying the electrical location of the AC-DC-GND, INPUT ATTEN, DISPLAY, COMPARISON VOLTAGE and MILLIVOLTS/DIV controls. Particularly, the diagram shows where the INPUT ATTEN switches are located with respect to the location of the MILLIVOLTS/DIV switch and the COMPARISON VOLTAGE control.

When applying a signal to the Type 3A7 input connector, attenuation of the signal takes place in the INPUT ATTEN

Operating Instructions-Type 3A7

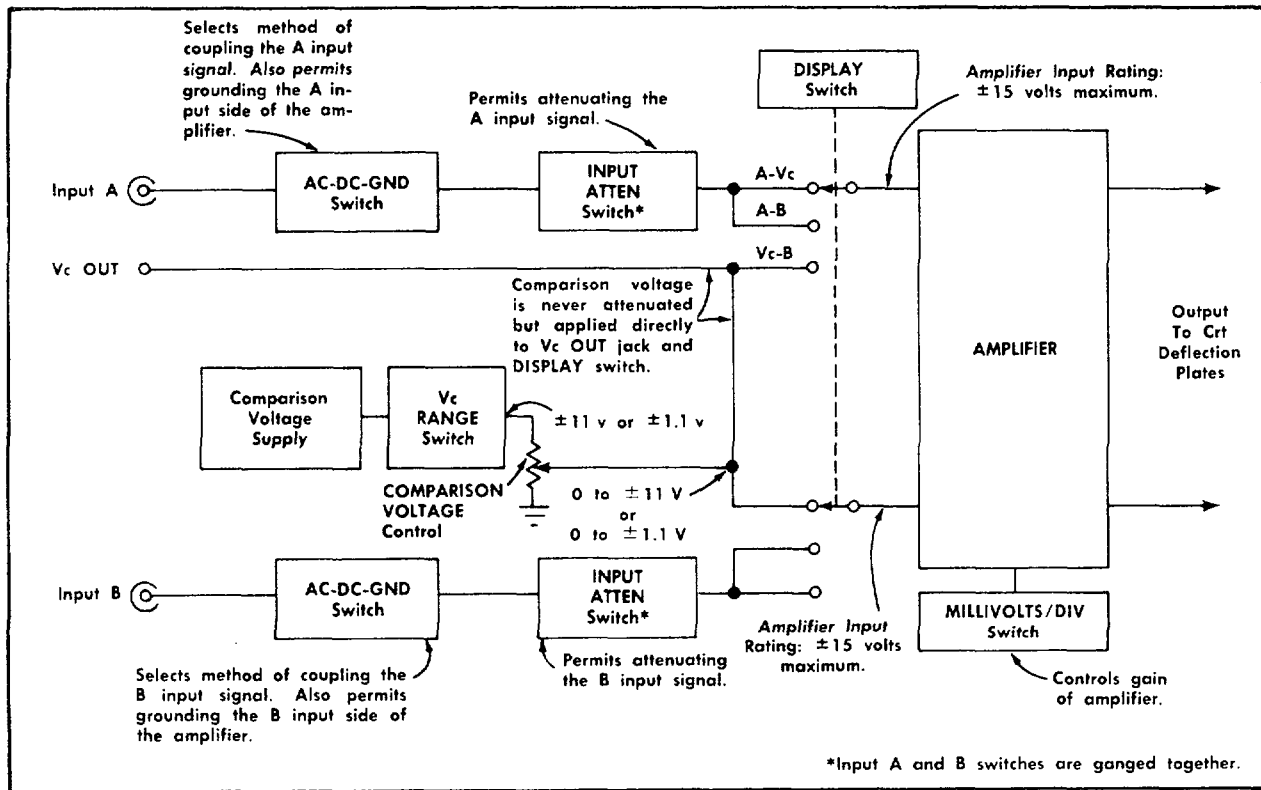

Fig. 2-4. Simplified block diagram showing DISPLAY switch position and Vc OUT connection.

switch before the signal is applied through the DISPLAY switch to the amplifier. The INPUT ATTEN switch does not attenuate the comparison voltage because the comparison voltage is applied directly to the amplifier input via the A-Vc or Vc-8 position of the DISPLAY switch.

It is also important to note that there are two ways to obtain the same sensitivity when using the INPUT ATTEN and MILLIVOLTS/DIV switches. One way gives more bandwidth; the other way gives less bandwidth but greater slide-back voltage capabilities. The methods that follow show two ways to obtain 10 mV/cm sensitivity, for example.

Method 1:

Set the INPUT ATTEN switch to 1 and the MILLIVOLTS/DIV switch to 10. This gives a bandwidth to 10 MHz for signals that do not overscan the screen. If the Type 3A7 is used as a differential comparator to offset a dc or low-frequency ac component of a signal, the maximum slide-back comparison voltage is 11 volts. For example, if +10 volts is applied to the Type 3A7, +10 volts of comparison voltage is needed to offset the 10 volts of applied voltage.

Method 2:

Set the INPUT ATTEN switch to 10 and the MILLIVOLTS/DIV

switch to 1. This gives a bandwidth of only 4 MHz for signals that do not overscan the screen, and the trace is slightly noisier. However, when using differential-comparator mode of operation to offset a dc or low-frequency component of a signal, the true slide-back voltage is 10 X greater using this method rather than Method 1. For example, if +10 volts is applied to the Type 3A7, the INPUT ATTEN switch attenuates the 10 volts to +1 volt using Method 2. A comparison voltage of only +1 volt is all that is needed to offset the +10 volts of applied voltage. Thus, the 10 volt of comparison voltage is really equivalent to 10 volts since it is capable of offsetting the +10-volt applied voltage.

Using differential-comparator operation and Method 2 (for example), ±110 volts can be applied to the Type 3A7 because the INPUT ATTEN switch setting of 10 attenuates the ±110 volts to 11 volts and this attenuated voltage is applied to the amplifier. The 11 volts is well within the ±15-volt rating of the amplifier stage and can be offset by using the ±11-volt maximum comparison voltage available within the unit. The COMPARISON VOLTAGE control dial indication is not affected by the setting of the MILLIVOLTS/DIV switch because the MILLIVOLTS/DIV switch acts as a null resolution or null sensitivity control during this mode of operation. True comparison voltage using either method can be determined using this formula:

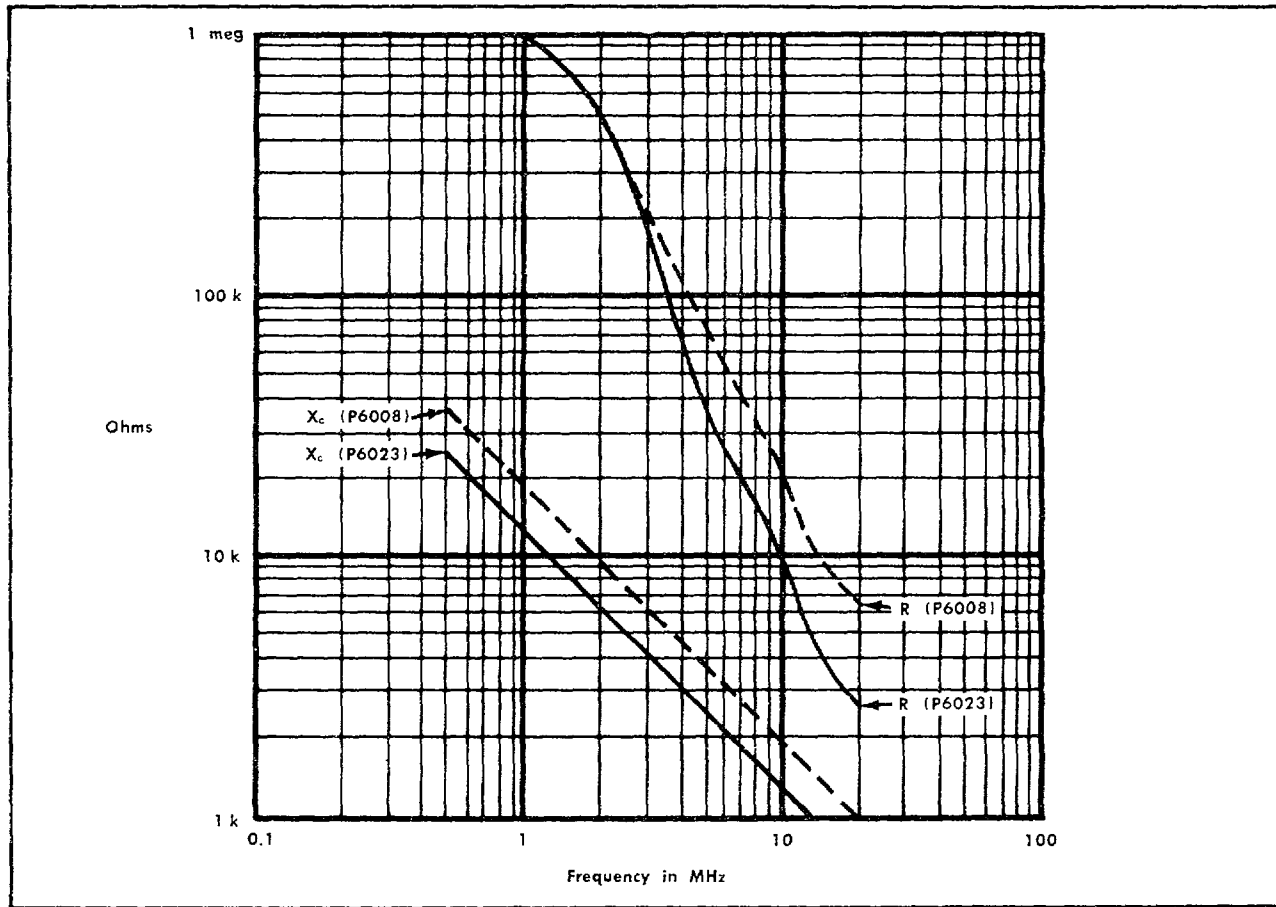

Fig. 2-5. Typical input resistance (R) and capacitive reactance (Xc) vs frequency curves obtained when P6008 and P6023 10X Probes are used with the Type 3A7. INPUT ATTEN switch set to 1.

True Comparison = Voltage	COMPARISON	INPUT	Probe Attenua- tion Factor
	VOLTAGE	ATTEN	
Control	Reading	Switch	X
in Volts	in Volts	Position:	X
		1, 10, 100	
		or 1000	

Input Signal Connections

Before connecting signals to the A and/or B connectors on the Type 3A7, consider the method that will be used. Table 2-1 lists a choice of eight different methods. For each method the table lists the advantages, limitations, accessories required, source loading and precautions to consider. Check through the table and select the method which is suitable for your particular application. Figs. 2-5 and 2-6 show input R and Xc vs frequency curves for three different probes which were connected to the Type 3A7. The INPUT ATTEN switch was set to 1 and a Boonton RX bridge was used to obtain the data for the curves.

Use of Attenuator Probes

Attenuator probes reduce loading of the signal source. However, in addition to providing isolation of the oscilloscope

from the signal source, an attenuator probe also decreases the amplitude of the displayed waveform by the attenuation factor of the probe. When making amplitude measurements with an attenuator probe, be sure to multiply observed amplitude by the attenuation of the probe.

An adjustable capacitor in the probe compensates the probe for variations in input capacitance between one plug-in and another. To assure the accuracy of pulse and transient measurements, this adjustment should be checked. To make this adjustment, proceed as follows:

1. Set the oscilloscope Amplitude Calibrator for an output of suitable amplitude.
2. Place the DISPLAY switch to the A-B position.
3. Set the AC-DC-GND switch to DC for the input in use. Set the unused input AC-DC-GND switch to GND.
4. Touch the probe tip to the calibrator output connector and adjust the oscilloscope controls to display several cycles of the waveform
5. Adjust the probe compensation for best square-wave response.

Operating Instruction-Type 3A7

TABLE 2-1
Signal Coupling Methods

Method of Coupling the Signal	Advantages	Limitations	Accessories Required	Source Loading ¹	Precautions
1. Open (unshielded test leads.	Simplicity	Limited frequency response. Subject to stray pickup.	BNC to banana jack adapter (103-0033-00). Two test leads.	1 MΩ and 20 pF at input, plus test leads and adapter.	Stray pickup and spurious oscillations. Insert series 47-ohm resistor.
2. 1X, 1MΩ probe.	Full sensitivity. Total Type 3A7/Oscilloscope bandwidth.	High capacitance of cable.	P6028 is 1X equipped with BNC connector.	1 MΩ and ≈ 60 pF.	High capacitance loading.
3. Unterminated coax cable.	Full sensitivity.	Limited frequency response. High capacitance of cable.	Coax cable with BNC connector(s).	1 MΩ and 20 pF plus cable capacitance.	High capacitance loading.
4. Terminated coax cable. Termination at Type 3A7 input.	Full sensitivity. Total Type 3A7/Oscilloscope bandwidth. Relatively flat resistive loading. Long cable with uniform response.	Presents Z _o (typically 50Ω) loading at end of coax. May need blocking capacitor to prevent dc loading or damage to termination.	Coax cable with BNC connector(s). Z _o termination at Type 3A7 input (BNC 50 Ω Termination, 011-0049-00.)	Z _o plus 20 pF at Type 3A7 end of coax can cause reflections.	Reflections from 20 pF at input. Dc and ac loading on test point. Power limit of termination.
5. Some as 4, with coaxial attenuator at termination.	Less reflection from 20 pF at termination.	Sensitivity is reduced (increased Deflection Factor).	BNC coaxial attenuators.	Z _o only.	Dc and ac loading on test point. Power limit of attenuator.
6. Tap into terminated coax system. (BNC T: UG-274/U at Type 3A7 input.)	Permits signal to go to normal load. Dc or ac coupling without coaxial attenuators.	20 pF load at tap point.	BNC T and BNC connectors on signal cables.	1 MΩ and 20 pF at tap point.	Reflections from 20 pF input.
7. 10X, 8 MΩ probe for P6023; 10MΩ for others.	Reduced resistive and capacitive loading, full Type 3A7/Oscilloscope bandwidth.	X0.1 sensitivity.	P6006, P6008 and P6023 and 10X.	P6006: ≈ 7 pF, 10MΩ. P6008: ≈ 7.5 pF, 10MΩ. P6023: ≈ 12 pF, 8MΩ.	Check probe frequency compensation. Use square-wave frequency less than 5 kHz.
100X, 10MΩ probe. 1000X, 100 MΩ.		X0.01 sensitivity. X0.001 sensitivity.	P6007: 100X. P6015: 1000X.	P6007: ≈ 2 pF, 10MΩ. P6015: ≈ 2.7 pF, 100MΩ.	
8. Current transformer. Terminated in 50Ω at Type 3A7. Bandwidth that of Type 3A7/Oscilloscope.	Current transformer can be permanent part of test circuit. Less than 2.2 pF to test circuit chassis. Measure signal currents in transistor circuits. CT-1: 20 amps peak. CT-2: 100 amps peak.	Rms current rating: CT-1, 0.5 amp; CT-2, 2.5 amps. Sensitivity: CT-1: 5 mV/mA. CT-2: 1 mV/mA.	CT-1: Coax adapter and BNC termination. CT-2: Nothing extra. (Perhaps additional coax cable for either transformer.)	CT-1: Insertion; 1Ω paralleled by about 5μH. Up to 1.5 pF. CT-2: Insertion: 0.04 Ω paralleled by about 5 μH. Up to 2.2 pF.	Not a quick-connect device. CT-1: Low frequency limit about 75 kHz. CT-2: Low frequency limit about 1.2 kHz, and is 1/5 as sensitive as the CT-1.

¹Applies to 1, 10, 100 and 1000 positions of the INPUT ATTEN switch.

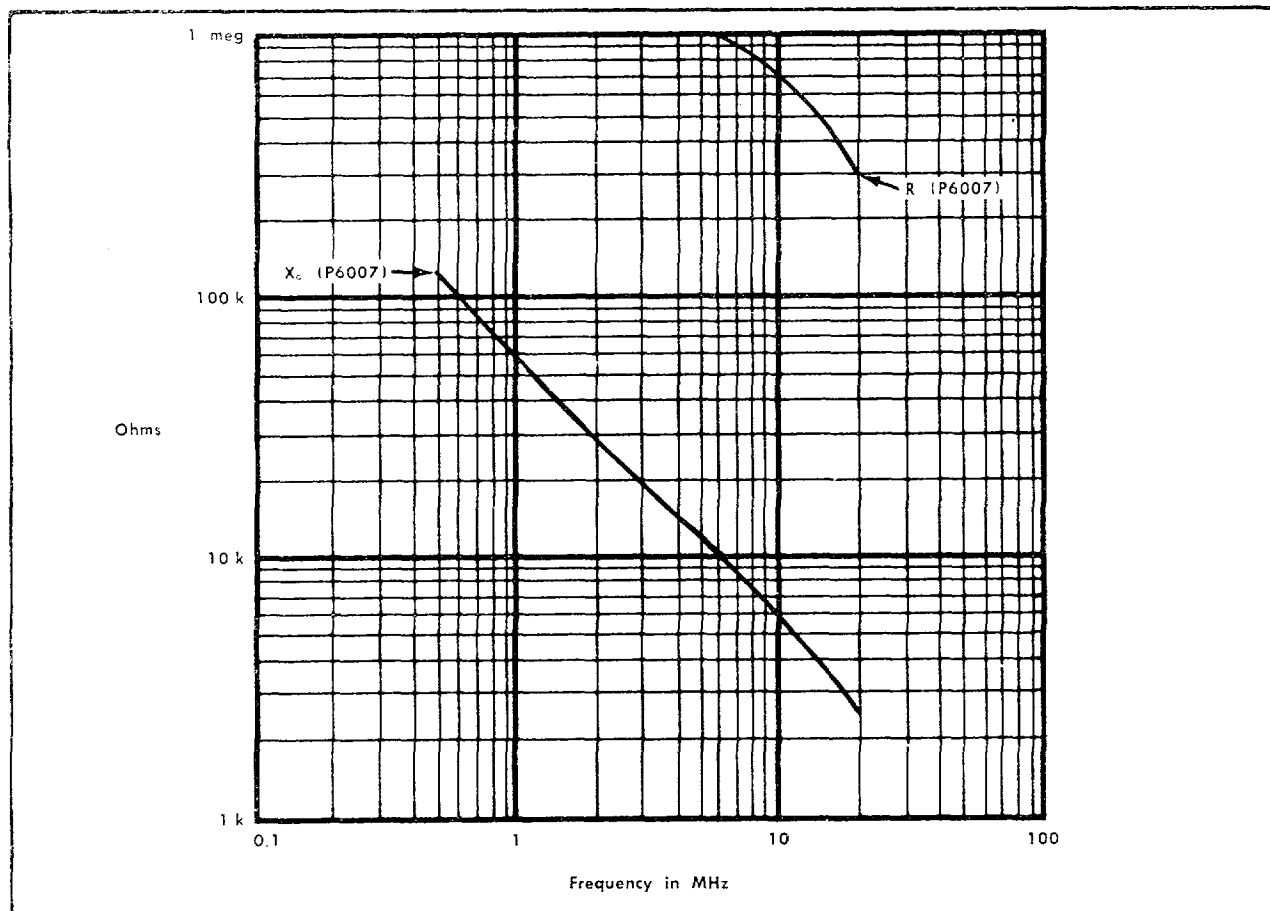

Fig. 2-6. Typical input resistance (R) and capacitive reactance (X_c) vs frequency curves obtained when a P6007 100X Probe is used with the Type 3A7.

NOTE

If a square-wave source other than the oscilloscope calibrator is used for compensating the probe, do not use a repetition rate higher than 5 kHz. At higher repetition rates, the waveform amplitude appears to change as the probe is compensated. Thus, proper compensation is difficult to attain. If the probe remains improperly compensated, transient and frequency response of the system will be poor and measurements will be inaccurate.

Modes of Operation

The Type 3A7 is used primarily for three basic modes of operation: (1) conventional amplifier, (2) differential amplifier, and (3) calibrated differential comparator. Table 2-2 shows where to set the front-panel controls for each operating mode.

For conventional-amplifier mode of operation, note that Table 2-2 shows two ways to set the controls when using either input. Further details about these two ways and the different modes of operation are given in the information that follows.

Conventional Amplifier Operation

When using the Type 3A7 as a conventional amplifier, there are two ways to set up the controls using either input. Assume the signal will be applied to input A to obtain an upright display (see Fig. 2-7). The two setup methods are as follows:

Method 1:

- a. Set the DISPLAY switch to A-B.
- b. Apply the signal to input A.
- c. Set the input A AC-DC-GND switch to AC or DC, depending on the method of signal coupling desired.
- d. Set the input B AC-DC-GND switch to GND.

Method 2:

- a. Set the DISPLAY switch to A-Vc and Vc RANGE switch to 0.
- b. Apply the signal to input A.
- c. Set input A AC-DC-GND switch to AC or DC, depending on the method of signal coupling desired. The

Operating Instructions-Type 3A7

TABLE 2-2
Mode of Operation

Mode of Operation	Connector to Use	Input A AC-DC-GND Switch	Input B AC-DC-GND Switch	DISPLAY Switch	Vc RANGE Switch
Conventional Amplifier	A	AC or DC	GND	A-B	Any Position
		AC or DC	Any Position ¹	A-Vc	0
	B	GND	AC or DC	A-B	Any Position
		Any Position ¹	AC or DC	Vc-B	0
Differential Amplifier	A and B	AC or DC	AC or DC	A-B	Any Position
Calibrated Differential Comparator	A	AC or DC	Any Position ¹	A-Vc	-11, -1.1, +1.1 or +11. See text.
	B	Any Position ¹	AC or DC	Vc-B	

¹Exception: Set to GND if a large signal is applied to the unused connector; prevents crosstalk.

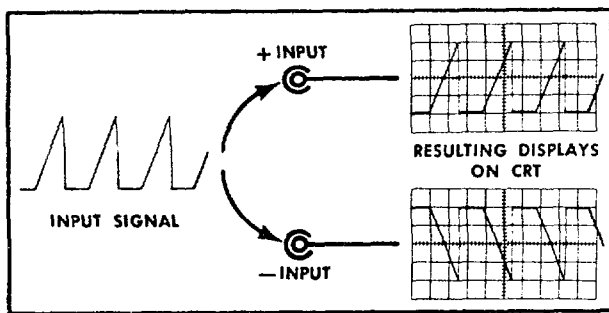

Fig. 2-7. Waveforms applied to the A input connector produce an upright display, while waveforms applied to the B input are inverted.

B input AC-DC-GND switch can be left in any position.

Conventional-amplifier mode of operation using input B instead of input A is essentially the same except that signals applied to input B connector are inverted on the screen. Positive voltages produce an upward deflection when applied to input A and a downward deflection when applied to input B (see Fig. 2-7).

The amount of vertical deflection produced by a signal is determined by the settings of the INPUT ATTEN, MILLIVOLTS/DIV and VARIABLE controls. Calibrated deflection factors indicated by the MILLIVOLTS/DIV switch apply only when the VARIABLE control is set to the CAL detent position. Serious errors in display measurements may result if the setting of this control is inadvertently moved away from the CAL position.

Range of the VARIABLE control is about 2.5 to 1 to provide continuously variable (uncalibrated) vertical-deflection factors between calibrated settings of the MILLIVOLTS/DIV switch. Use of this control extends the 50 MILLIVOLT/DIV position to at least 125 mV/div. As the control is rotated a few degrees counterclockwise from the CAL position, a switch is actuated which increases the gain of the amplifier about 10%.

This increased gain assures overlapping coverage between the calibrated steps.

Voltage measurements in mV may be made directly from the crt by noting the amount of vertical deflection in major divisions of the crt. Then, multiply the vertical deflection in divisions by the setting of the MILLIVOLTS/DIV switch, the setting of the INPUT ATTEN switch and the attenuation factor, if any, of the probe. (Be sure the VARIABLE control is set to CAL) The following formula summarizes the measurement:

$$\text{Peak-to-Peak Amplitude in = Millivolts}$$

$$\text{Vertical Deflection in Divisions} \times \text{MILLIVOLTS/DIV Switch Position} \times \text{INPUT ATTEN Switch Position} \times \text{Probe Attenuation Factor}$$

When using the AC-DC-GND switch for coupling the signal from its associated connector to the input circuit of the Type 3A7 amplifier, the AC position inserts a dc blocking capacitor in series with the input circuit. The input time constant for the AC position is about 0.08 second. Low frequency response is 30% down at about 2 Hz. Two occasions when ac coupling is used are:

1. When it is desired to get a quick look at the ac component of a signal which has a large dc component.
2. To measure the peak-to-peak voltage of the ac component while blocking the dc component.

In the DC position of the AC-DC-GND switch, both the ac and dc components of an applied signal can be observed. This position is useful for measuring dc levels of voltages or for measuring the instantaneous dc level at a given point on a waveform.

The GND position of the AC-DC-GND switch allows the signal to be disconnected from the Type 3A7 amplifier input

Operating Instruction-Type 3A7

without having to physically disconnect the applied signal externally. The GND position also grounds the amplifier input circuit to provide an easy method for establishing or checking the zero dc reference of the trace. However this method does not take into account trace deviation from exact zero due to ground-loop and grid currents. If voltages due to these currents are significant and utmost measurement accuracy is desired, set the AC-DC-GND to DC and touch the probe tip to chassis ground on the device under test. Then check or position the trace to zero dc reference.

Differential Amplifier Operation

The primary purpose of differential-amplifier mode of operation is to eliminate common-mode signals. The term "common-mode signals" is defined as two signals applied to a differential amplifier that are identical to each other with respect to amplitude and time. This term is also used to identify the respective parts of two signals that are identical.

A differential amplifier, such as the Type 3A7 and oscilloscope used in conjunction with each other, is simply a difference amplifier (not a differentiation amplifier). A difference amplifier amplifies and displays the voltage difference between two signals as expressed in this formula:

$$\text{Signal}_{\text{diff}} = A - B$$

Due to slight dissimilarities between the two sides of a differential amplifier, some difference voltage will be displayed even though the input signals are common-made (identical). The ratio of the amplitude of this difference signal and the amplitude of the common-made input voltage is called common-made rejection ratio (CMRR).

Major factors affecting the CMRR of a differential amplifier are: dynamic range of the amplifier, method of signal coupling (ac or dc), frequency and transient response. For the type 3A7, CMRR is greater than 20,000:1 for dc-coupled signals below 20 kHz and greater than 500:1 for dc-coupled 500:1 signals. For additional CMRR information refer to the Characteristics section of this manual.

Differential operation between the two inputs of the Type 3A7 is obtained by setting the DISPLAY switch to A-B and AC-DC-GND switched to AC or DC, depending upon the method of coupling desired. For maximum common-mode rejection, both AC-DC-GND switches should be set to the same position (preferably to DC) and the VARIABLE control set to CAL. To obtain high common-mode rejection when using attenuator probes, use probes that have variable R and C as the Tektronix P6023 Probe. An adjustment procedure for the probes follows.

NOTE

If the probes are used with a floating input, the ground straps can be connected together but not connected to the circuit under measurement. This arrangement may aid in reducing pickup of spurious radiated signals.

Differential-amplifier mode of operation can be used, for example, to observe the signal across one circuit element while effectively eliminating the remainder of the circuit from the observations. This is accomplished by connecting the signal at one end of the element to one input of the Type 3A7 and the signal at the other end of the element to the other input of the unit.

Fig. 2-8 waveforms show pictorially the ability of the Type 3A7 to reject common-mode signals so the desired signal can be displayed. In this example, the signal applied to input A (see Fig. 2-8a) is 10 volts peak to peak of 60 Hz hum modulated by a 1-kHz 5-mV square-wave signal. The very top portion of the composite signal is shown in Fig. 2-8b. The waveform is 2,000 divisions high and differential-comparator operation is used to position the top of the waveform into view. Since the square-wave signal is not synchronized with the hum signal, the free-running square-wave signal causes the double appearance of the hum waveform, (Stable triggering occurs on the hum signal because it is the dominant signal.)

To display only the square-wave signal for observation and measurement, it is necessary to reject the hum portion of the input-A composite signal. To do this, an unmodulated hum signal (which is identical to the hum portion of the signal at input A) is applied to input B as shown in Fig. 2-8c. Since the hum signals are common-mode, they will be rejected by the Type 3A7 at CMRR of 20,000:1 or better using dc coupling. Thus, 10 volts of hum divide by 20,000 or better results in a difference hum voltage of 0.5 mV or less in amplitude (see Fig. 2-8d).

The square-wave signal, which is not common-mode, is clearly visible in Fig. 2-8d for easy measurement, use the same formula as the given for conventional amplifier operation.

P6023 Probe Adjustment Procedure

For this procedure the following equipment is recommended:

- 1-Oscilloscope with time base. Oscilloscope accepts Type 3A7 plug-in unit.
- 1-Type 3A7 Differential Comparator plug-in unit.
- 1-P6023 Probe (two required for differential operation).
- 1-BNC dual binding post adapter. Tektronix Part No. 103-0035-00.
- 1-Resistor, fixed 1.2 megohm, 1/8 W to 1/2 W, 1%.
- 1-50-ohm (nominal impedance) coaxial cable, 18 inches long, with a BNC connector on each end.

Procedure:

- a. Insert the Type 3A7 into the oscilloscope (vertical) plug-in compartment. Turn on the oscilloscope and allow about 15 minutes for warm up.

NOTE

Be sure the DIFF BAL and AMP CAL controls are properly adjusted before adjusting the probes.

- b. Set the front-panel controls as follows:

Type 3A7	
V _c RANGE	0
COMPARISON VOLTAGE	4-9-0 ¹
AC-DC-GND (A and B)	GND
INPUT ATTEN	10
DISPLAY	A-Vc
MILLIVOLTS/DIV	50
VARIABLE	CAL
POSITION	Centered

¹ Dial reading.

Operating Instruction-Type 3A7

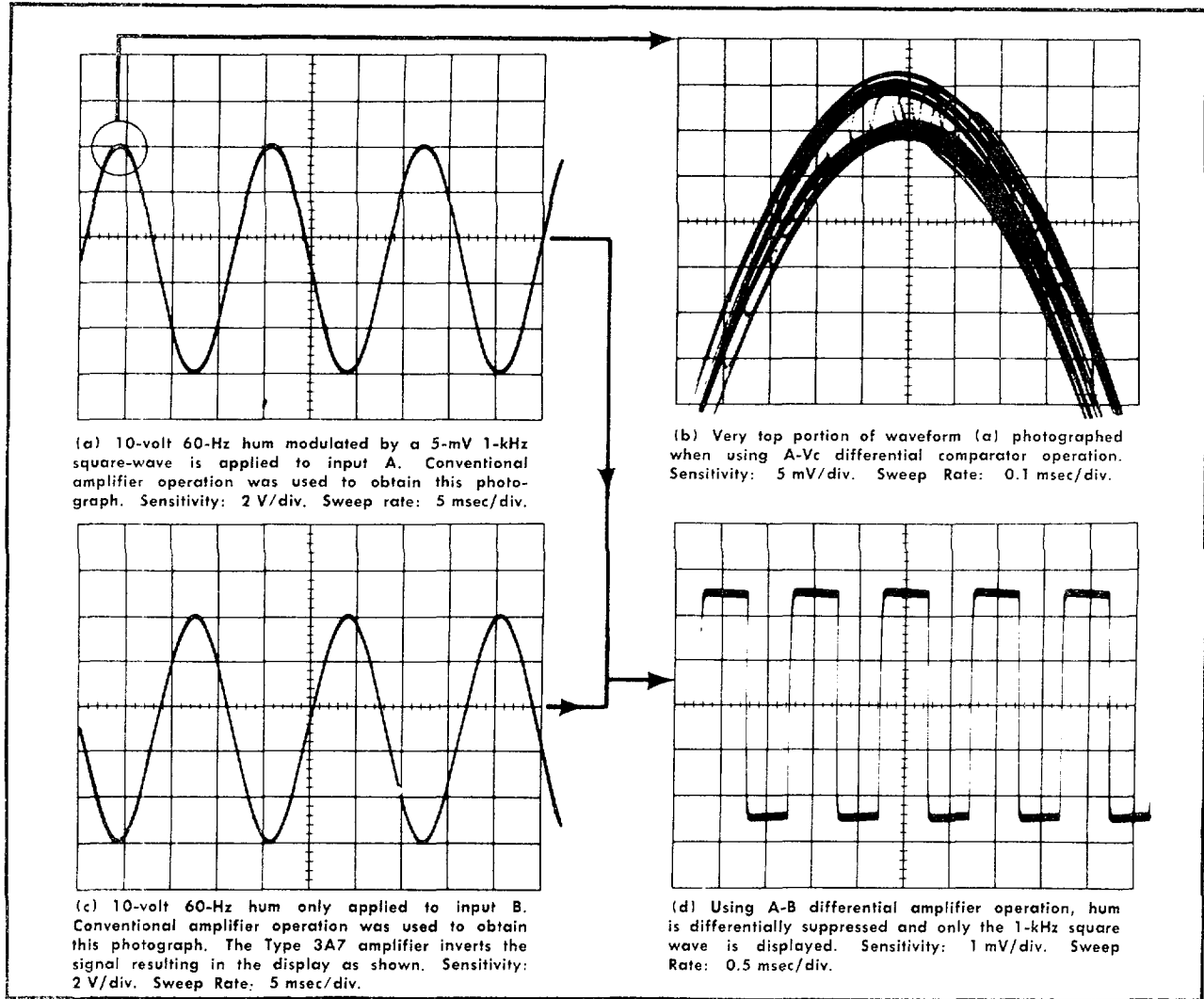

Fig. 2-8. Common-mode rejection by the Type 3A7.

Time Base

Position	Centered
Time/Div	.5 mSec
Variable	Calibrated
Pull 5X Mag	In
Mode	Norm
Level	Auto
Slope	+
Coupling	AC Slow
Source	Line ¹

Other

Calibrator	50 Volts
------------	----------

c. Check that the oscilloscope Intensity control is set for normal brightness.

¹Set to Int if a 1-kHz calibrator signal source is used.

d. Using the Type 3A7 POSITION control, position the trace so it coincides with graticule center. This is the zero reference for the trace.

e. Connect a coaxial cable from the A input connector to the Cal Out connector.

f. Set the +INPUT switch to DC and the Vc RANGE switch to +11.

g. Set the COMPARISON VOLTAGE control so the top of the waveform (about +50 V) is positioned to graticule center as shown in Fig. 2-9a.

NOTE

Set the time-base Time/Div switch and, if necessary, the Variable (Time/Div) control so two cycles are displayed as shown in Fig. 2-9a.

h. Set the Vc RANGE switch to 0 and the A input AC-DC-GND switch to GND. Readjust the POSITION control so the trace coincides exactly with graticule center.

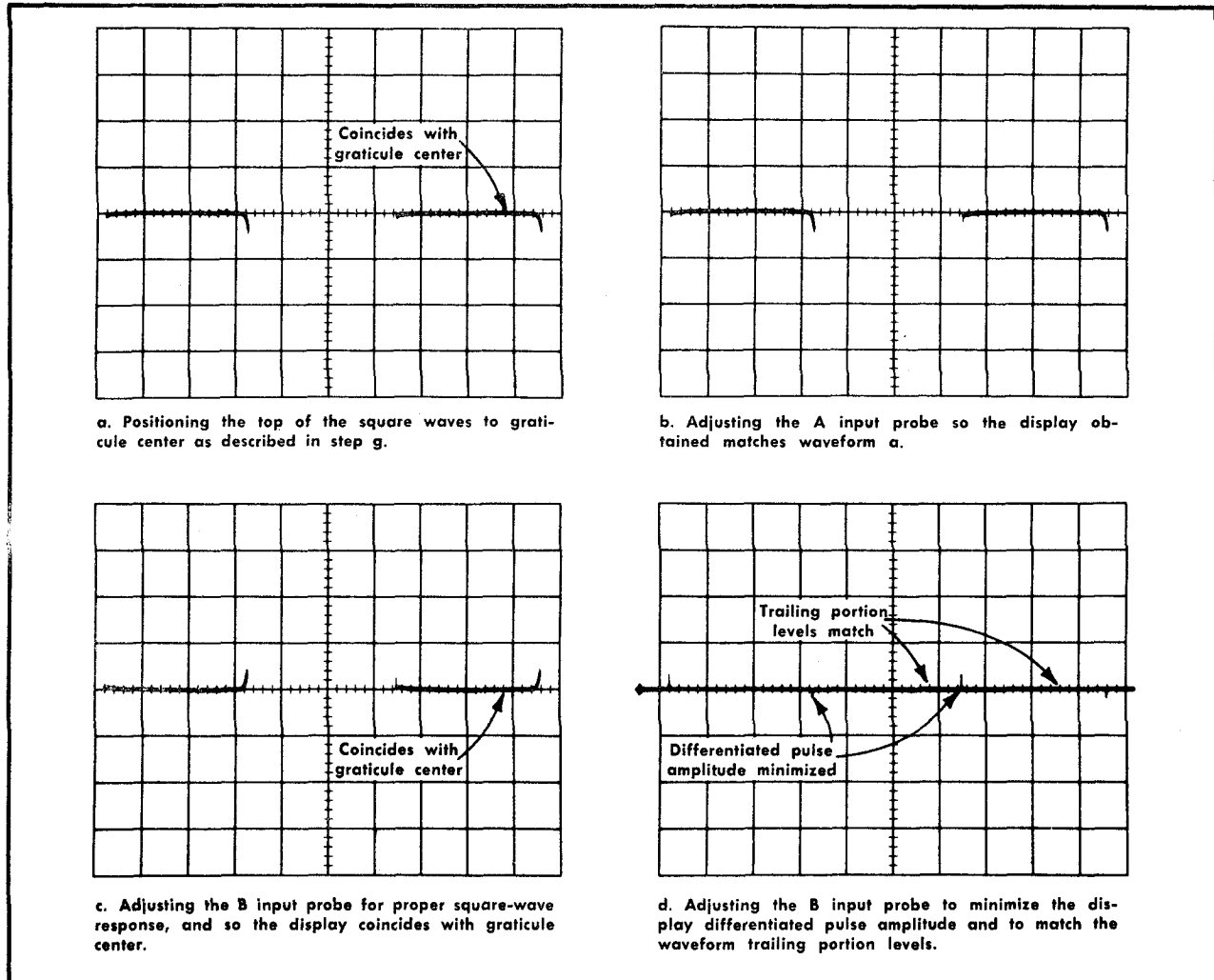

Fig. 2-9. Using calibrated differential-comparator operation to adjust the probes for single-ended operation and using differential-amplifier operation to match the B input probe to the A input probe. Line-frequency calibrator signal was used to obtain the waveform displays. Similar displays can be obtained using a 1-kHz calibrator signal source.

i. Set the A input AC-DC-GND switch to DC and the Vc RANGE switch to +11. Readjust the COMPARISON VOLTAGE control so the trailing portion of the waveform coincides exactly with graticule center (same as shown in Fig. 2-9a).

IMPORTANT
Leave the COMPARISON VOLTAGE control at this setting for the rest of the procedure.

j. Remove the coaxial cable. Connect the dual binding post adapter to the oscilloscope Cal Out connector. Connect a 1.2-megohm (1%) resistor between the binding posts on the adapter. (The resistor together with the probe input resistance simulates the same load for the calibrator as the input resistance of the plug-in unit used in performing steps e through i.)

k. Connect the compensator box of a P6023 Probe to the A input connector. Connect the probe tip to the red terminal (Cal Out) on the adapter. Fig. 2-10 shows the setup.

l. Set the INPUT ATTEN switch to 1.

m. Adjust the probe DC Atten Calibration control so the trailing portion of the waveform coincides exactly with graticule center. Then, adjust the probe AC Coarse Comp and AC Comp Fine Adjust controls to duplicate the display obtained in step g. Fig. 2-9b shows a typical waveform that should be obtained if the probe is properly adjusted. The oscilloscope line-frequency calibrator was used as the signal source. Similar results are obtained using a 1-kHz calibrator as the signal source.

NOTE

To double-check that the trailing portion of the waveform and zero-trace reference match, set the Vc RANGE switch to 0 and the A input switch to GND. If necessary, readjust the POSITION control to make the trace coincide with graticule center. Return the switches to their former position. If necessary, repeat step m. The A input probe is now adjusted accurately for ac and dc signal measurements.

Operating Instructions-Type 3A7

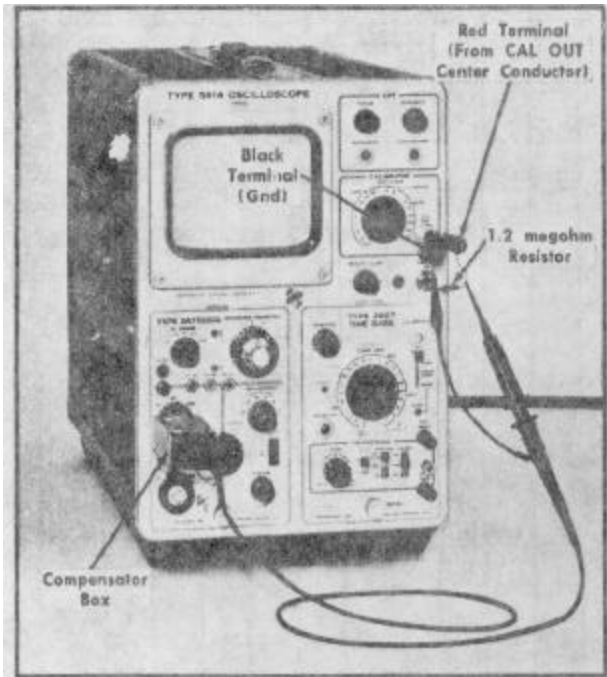

Fig. 2-10. Setup for adjusting the A input probe.

- n. To adjust a second probe, connect the compensator box of the second probe to the B input connector and connect the probe tip to the red terminal on the adaptor at the Cal Out connector.
- o. Set the Type 3A7 controls as follows:

AC-DC GND (A)	GND
AC-DC GND (B)	DC
DISPLAY	Vc-B

p. Using step m as a guide, adjust the B input probe compensation controls. The display will be inverted and should appear similar or to the waveform shown in Fig. 2-9c.

NOTE

To double-check that the waveform and zero reference are matched when using step m as a guide, set the Vc RANGE switch to 0 and the B input switch to GND. After making the check, return the switches to their former positions. The B input probe is now adjusted accurately for performing ac and dc single-ended measurements.

q. To match the B input probe to the A input probe for performing differential measurements, set the Type 3A7 controls as follows:

AC-DC GND (A)	DC
DISPLAY	A-B

r. Slightly readjust the B input probe compensation controls to obtain a display having minimum differentiated pulse amplitude, and so that the trailing portion levels of the waveform are matched; that is, a minimum-amplitude display. Fig. 2-9d shows a typical display that should be obtained when the B input probe is properly adjusted.

Calibrated Differential Comparator Operation

When the DISPLAY switch is set to A-Vc or Vc-B and the Vc RANGE switch is set to one of the + or - voltage ranges, the Type 3A7 is operating as a calibrated differential computer or slide-back voltmeter. The calibrated comparison voltage, which has a range of 0 to +11 volts, can be added differentially (see Fig. 2-4) to either input signal to move the signal up or down. For linear operation and maximum input voltage ratings, Table 1-3 in the Characteristics section lists the maximum input signal that can be applied to the Type 3A7 input connector.

NOTE

For precise measurement accuracy when using a probe with the Type 3A7, use a probe that has variable R and C such as P6023 Probe. See probe adjustment procedure on page 2-9.

As shown in Fig. 2-4, the calibrated dc comparison voltage is internally applied to the amplifier. The voltage can be used to differentially offset any unwanted portion of the applied signal: thereby allowing measurements of relatively small ac or dc signals modulating relatively large ac or dc signals.

In the A-Vc position of the DISPLAY switch, the comparison voltage is internally applied to the amplifier input where the B signal is ordinarily applied during differential-amplifier mode of operation. The AC-DC-GND switch in the B side is not used (see Fig. 2-4). Thus, signals applied to the B input connector will not be displayed.

In the Vc-B position of the DISPLAY switch, the comparison voltage is applied to the amplifier, input where the A signal is normally applied during differential-amplifier mode of operation. The AC DC-GND switch and input connector for the A input are not used.

NOTE

If a high amplitude signal is applied to the unused connector, the AC-DC-GND switch for that connector should be set to GND to prevent crosstalk.

The dc comparison voltage is set by two controls: the Vc RANGE switch and the COMPARISON VOLTAGE control. The Vc RANGE switch has 4 ranges: 0 to -11, 0 to -1.1, 0 to +1.1, and 0 to +11 volts. The COMPARISON VOLTAGE control varies the comparison voltage over the range set by the Vc RANGE switch and indicates the precise comparison voltage at a particular setting. The outer knob on the control is a switch that selects the first digit and the dial which is coupled to a 10-turn potentiometer selects the remaining digits. The comparison voltage as read from the COMPARISON VOLTAGE control is independent of the MILLIVOLTS/DIV or VARIABLE control.

NOTE

The comparison voltage supply in the Type 3A7 stays constant and is accurate as long as the oscilloscope regulated power supplies are in regulation and within their output voltage tolerance ratings. Be sure the regulated power supplies in the oscilloscope are operating properly.

When using the COMPARISON VOLTAGE control for Vc measurements, the MILLIVOLTS/DIV and VARIABLE controls

Operating Instruction-Type 3A7

act as null resolution or vertical-display magnifier controls. If the controls are changed during a readout, possible trace shift may occur due to slight dc-level changes in the Type 3A7 amplifier. To make sure the readout has not been affected, recheck the measurement by checking that the pre-established reference and Vc-offset trace positions agree. For example, refer to step i in the Measuring Dc Voltages procedure.

Differential comparator mode of operation may be used to make the following basic voltage measurements: (1) measuring dc voltages, (2) measuring small ac or dc signals superimposed on dc, (3) measuring small ac signal variations on large ac signals, and (4) measuring high-amplitude low-frequency ac signals.

(1) Measuring Dc Voltages

To measure dc voltages the following basic procedure, using input A as an example, can be used as a guide.

- a. Check that the DC BAL adjustment has been set properly.
- b. Place both AC-DC-GND switches to GND, the DISPLAY switch to A-B and the MILLIVOLTS/DIV switch to 50.
- c. Preset the INPUT ATTEN switch so the expected dc voltage to be applied in step f will be less than 11 volts to the Type 3A7 amplifier. For example, if the dc voltage at the input A connector is expected to be about +30 volts when step f is performed, preset the INPUT ATTEN switch to 10.
- d. Preset the Vc RANGE switch to a range that is sufficient to offset the attenuated dc voltage. Use a range which has the same polarity as the voltage to be applied in step f. (Using the example in step c, the Vc RANGE switch would be preset to +11.)
- e. Establish a reference line on the crt. This line will usually be the horizontal centerline of the graticule. Use the POSITION control to set the trace to the reference line. Once the trace is set, do not move the POSITION control until the measurement has been completed or a recheck is necessary.

NOTE

For greatest accuracy in establishing a reference, set the input A AC-DC-GND switch to DC and touch the probe tip to ground on the device under test. Then position the trace to the reference line.

- f. Connect input A probe to the dc voltage to be measured.
- g. Set the input A AC-DC-GND switch to DC and the DISPLAY switch to A-Vc.
- h. Set the COMPARISON VOLTAGE control to bring the trace on the crt. Set the trace exactly on the reference line using the COMPARISON VOLTAGE control.
- i. Recheck the reference by setting the input A AC-DC-GND switch to GND (or ground the probe tip) and the DISPLAY switch to A-B

NOTE

When making large dc measurements, allow a few moments for the trace to return to its original position.

- i. Now the voltage can be determine by using the following formula:

$$\begin{matrix} \text{True} & & \text{COMPARISON} & & \text{INPUT} & & \text{Probe} \\ \text{Comparison} & = & \text{VOLTAGE} & & \text{ATTEN} & & \text{Attenuation} \\ \text{Voltage} & & \text{Control} & \times & \text{Switch} & \times & \text{Factor} \\ \text{in Volts} & & \text{Reading} & & \text{Position} & & \\ & & \text{in Volts} & & & & \end{matrix}$$

The applied dc voltage is equal to the true comparison voltage. For example, supposing a +300-volt power supply is being measured and a 10X attenuator probe is used to connect to the power supply test point. Finally, assume that the INPUT ATTEN switch has been set to 10, the Vc RANGE switch to 10X one the COMPARISON VOLTAGE control to 2-9-85 (+2.985 volts). Substituting these values in the formula, the result is:

$$\text{True Comparison Voltage} = (+ 2.985) (10) (10)$$

$$\text{True Comparison Voltage} = +298.5 \text{ volts}$$

Thus, the +300-volt supply is actually +298.5 volts

NOTE

To increase the resolution when matching the reference line and trace as in step h, set the MILLIVOLTS/DIV switch to a higher sensitivity (lower deflection factor). Re-establish the reference and repeat the measurement as described in steps i and j. The formula given in step i applies regardless of the MILLIVOLTS/DIV switch position.

(2) Measuring Small Ac or Dc Signals Superimposed on Dc.

Small ac or dc signals superimposed on (or modulating) a large dc component can be measured accurately by first using the comparison voltage to effectively offset the dc component. The general procedure, using input A as the example, is as follows:

- a. Set both AC-DC-GND switches to GND, the DISPLAY switch to A-B and the POSITION control to midrange. Check that the DC BAL control is properly adjusted.
- b. Preset the INPUT ATTEN switch so the expected composite signal applied to input A in step e will be less than 11 volts.
- c. Preset the Vc RANGE switch to a range that is sufficient to offset the expected attenuated signal. Use a range which has the same polarity as the large dc-component signal voltage to be offset.
- d. Preset the MILLIVOLTS/DIV switch so the small superimposed ac or dc signal is not expected to overscan the screen.
- e. Apply the signal to input A.
- f. Set the input A AC-DC-GND switch to DC and the DISPLAY switch to A-Vc.

Operating Instruction-Type 3A7

g. Set the COMPARISON VOLTAGE control so the small ac or dc signal is positioned on the screen.

h. Measure the small ac or dc signal in the same manner as is done in conventional-amplifier mode of operation using the usual formula.

$$\text{Peak-to-Peak Signal in Millivolts} =$$

$$\text{Vertical Deflection in cm} \times \text{MILLIVOLTS/DIV Switch Position} \times \text{INPUT ATTEN Switch Position} \times \text{Probe Attenuation Factor}$$

Or, measure the signal by using the COMPARISON VOLTAGE control. First, use the COMPARISON VOLTAGE control to measure the difference between the lowest and highest points on the small ac or dc signal. Substitute this data in the following formula:

$$\text{Peak-to-Peak Signal in Volts} =$$

$$\text{COMPARISON VOLTAGE Control Measurement in Volts} \times \text{INPUT ATTEN Switch Position} \times \text{Probe Attenuation Factor}$$

(3) Measuring Small AC Signal Variations on Large AC

The technique for measuring small ac-signal component variations on a large ac signal is essentially the same as that described for measuring small ac or dc signals superimposed on dc. The only difference is that the AC-DC-GND switch can be set to AC to block any dc component, if desired. The comparison voltage is then used to position the small ac signal component into view so the measurement can be made.

(4) Measuring High-Amplitude Low-Frequency AC Signals

High-Amplitude low-frequency (below 20 kHz) ac signals, up to 500 volts peak to peak applied to the Type 3A7 input connector, can be measured using the slide-back technique. This type of measurement is very similar to dc measurements except that it is not necessary to establish a zero voltage reference line. The procedure is as follows:

- a. Set both AC-DC-GND switches to GND, the DISPLAY switch to A-B and the MILLIVOLTS/DIV switch to 50.
- b. Preset the INPUT ATTEN switch so the expected ac signal to be applied in step d will be less than 11 volts peak amplitude to the Type 3A7 amplifier.
- c. Preset the Vc RANGE switch to a range sufficient to offset the peak-amplitude attenuated signal. Use either polarity for this step.
- d. Apply the signal to the A input connector.
- e. Set the input A AC-DC-GND switch to DC and the DISPLAY switch to A-Vc.

f. Use the COMPARISON VOLTAGE control to bring the desired point on the waveform to graticule center. Note the dial reading.

g. Set the Vc RANGE switch to a range which is opposite in polarity to that used in step c.

h. Use the COMPARISON VOLTAGE control to bring the other desired point on the waveform to graticule center. Note the dial reading.

i. Determine the peak-to-peak voltage by adding the absolute values of the two dial readings obtained in steps f and h by adding their absolute values. Then substitute this information in this formula:

$$\text{Peak-to-Peak Signal in Volts} = \text{COMPARISON VOLTAGE Control Difference Measurement} \times \text{INPUT ATTEN Switch Position} \times \text{Probe Attenuation Factor}$$

Vc OUT Jack

The Vc OUT tip jack mounted on the front panel of the Type 3A7 permits monitoring the internal comparison voltage. The voltage at the jack is the same as that set up by the Vc RANGE and COMPARISON VOLTAGE controls, providing the monitoring voltmeter loading is no greater than one or two microamperes. Any infinite impedance voltmeter such as a digital voltmeter or any nulling type meter which draws negligible current can be used for monitoring purposes.

If the Vc OUT jack is loaded more than two microamperes by an external meter, the comparison voltage available at the jack (and applied to the input grid of the Type 3A7 amplifier) will not be the same as indicated by the COMPARISON VOLTAGE control. However, the monitoring voltmeter which is connected to the Vc OUT jack will indicate the actual slide-back voltage. Therefore, it is possible to load the circuit considerably and still use the comparison voltage with satisfactory accuracy as long as the COMPARISON VOLTAGE dial reading is ignored and the reading of the voltmeter is used.

NOTE

Accidental grounding of the Vc OUT jack will not damage the internal circuitry of the Type 3A7.

R → ∞ Position of the INPUT ATTEN Switch

When the INPUT ATTEN switch is set to R ∞ as position, the A and/or B input connectors are connected via the AC-DC-GND and DISPLAY switches directly to the grid of the first stage. The grid-to-ground circuit, however, is opened. For low-frequency measurements the input impedance is very high. This permits accurate voltage measurements of a standard cell, for example, to be made. Any voltage within the ±11-volt range of the Type 3A7 can be measured using differential-comparator mode of operation. At null, the COMPARISON VOLTAGE control reading is equal to the voltage applied to the connector.

Operating Instruction-Type 3A7

NOTE

When using the R \rightarrow ∇ position, be sure to set the AC-DC-GND switch to DC for the input to be used. Dc coupling permits the grid to be returned to ground through the device under test.

If the device under test does not provide a dc return path for the grid, then an external resistance (adequately

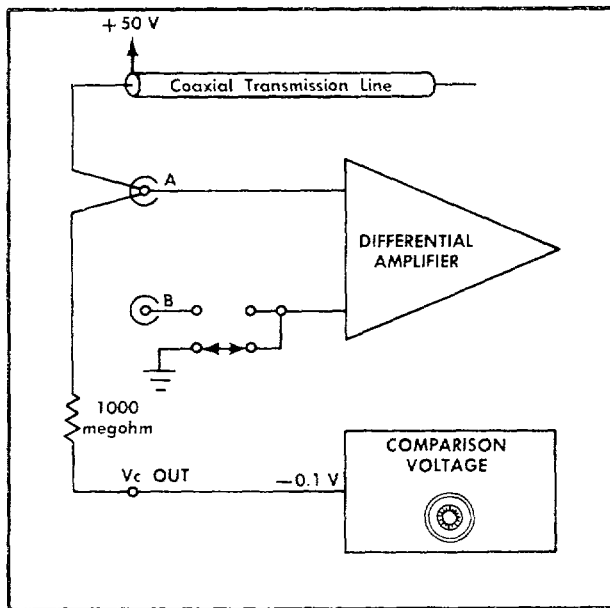

Fig. 2-11. Using the Type 3A7 to measure transmission line leakage.

shielded) must be connected between the input connector and ground. (If the resistance is large, connect the resistor

between the input and Vc OUT connectors as described in an example that follows.) A practical resistor value to use for this purpose is 1000 megohms. If this value of resistance is used, the input resistance of the Type 3A7 will be approximately 1000 megohms.

Grid current through a 1000-megohm resistor is typically on the order of 100 picoamperes but never exceeds 2 nanoamperes. This low current can be easily offset by the comparison voltage.

For example, if the A input is used, connect the 1000-megohm resistor between the A input connector and the Vc OUT jack. Set the input A AC-DC-GND switch to DC and input B AC-DC-GND switch to GND. Set the DISPLAY switch to A-B and the Vc RANGE switch to -1.1. Then, set the COMPARISON VOLTAGE control so the trace returns to a graticule line for use as a reference.

In the previous example, assume the grid current through the 1000-megohm resistor is 100 picoamperes. This is equal to a 100-mV drop across the resistor or 20 div of vertical deflection on the crt using a deflection factor of 5 mV/cm. This deflection can be offset by setting the COMPARISON VOLTAGE control to -0.1 volt (1-0-0). Once the reference is established, the Type 3A7 can be used as a current meter for making 5 picoamp/div measurements.

Using the previous example described, dynamic measurements of extremely high values of leakage resistance not ordinarily possible with the usual 1-or 10-megohm input resistance can be made. Transmission line leakage resistance as shown in Fig. 2-11, for example, can be measured by connecting a well-filtered dc voltage source between the ungrounded shield of the coax and ground. The center conductor of the coax is connected to the Type 3A7 input connector. For this application, assume +50 volts is applied to the shield and the trace moves two divisions from the pre-established reference. This is equal to 10 picoamperes of current. Using Ohm's law the leakage resistance would be 5×10^{12} ohms.

SECTION 3 CIRCUIT DESCRIPTION

Introduction

For the block-diagram and detailed-circuit descriptions that follow, assume the Type 3A7 is inserted in the left-hand or Y-axis opening to provide vertical deflection and a time-base plug-in unit is inserted in the right-hand or X-axis plug-in opening to provide horizontal deflection. Block and schematic diagrams are located in Section 8 of this manual.

BLOCK-DIAGRAM DESCRIPTION

The DISPLAY switch, as shown on the block diagram, controls the mode of operation for Type 3A7. For example, with the switch set as shown, the unit is set for differential-comparator mode of operation. A signal applied to the input A connector passes through the input alternator (INPUT ATTEN A) and DISPLAY switch to the Input A CF (Cathode Follower) stage.

At the B side with the DISPLAY switch set as shown, a signal applied to the input B connector is disconnected from the B side of the amplifier by means of the DISPLAY switch. Instead, the DISPLAY switch connects a comparison voltage (V_c) to the B side of the amplifier. The comparison voltage is used to differentially offset the signal applied to the A side to make high-resolution ac and dc voltage measurements.

Accurate \pm dc comparison voltages are obtained from the V_c Supply. The comparison voltage is applied to the V_c RANGE switch SW410 which selects the comparison voltage range and polarity. From the V_c RANGE switch, the comparison voltage is applied to the COMPARISON VOLTAGE control which is an 11-position switch SW420 and a 10-turn potentiometer. The switch selects the first digit and the 10-turn potentiometer selects the remaining digits. The adjustable comparison voltage is applied at all times to the V_c OUT jack. In addition, it can be applied to either side of the amplifier via the DISPLAY switch, or not at all. In differential-comparator mode of operation, for example, the voltage is applied to one Input CF and the signal is applied to the other.

If the DISPLAY switch is set to A-B, signals which are applied to the input A and input B connectors pass through the input attenuators and DISPLAY switch to the input cathode followers for differential-amplifier operation. If the DISPLAY switch is set to V_c -B, the signal at the input B connector is applied to the Input B CF for differential-comparator operation.

The low-capacitance, high-impedance input of the Input CF stages isolate the input circuit from the stages that follow. The Input CF stages are designed to accept signals as great as ± 15 volts without being overloaded. Within this dynamic range, special bootstrap and constant-current circuits prevent the cathode followers from cutting off or drawing grid current when low-frequency, high-amplitude signals are applied to the Type 3A7.

The output of the Input CF stages is applied to the Comparator stage that operates as a differential comparator or differential amplifier, depending on the mode of operation being used. The Comparator stage uses constant current circuits to permit handling large signals without distortion. Gain of the stage, and hence the vertical deflection factor, is controlled by the MILLIVOLTS/DIV switch SW150.

In differential-comparator mode of operation the comparison voltage adds differentially to the signal within the Comparator stage. In differential-amplifier operation, signals which are applied on to both input connectors add differentially in this stage. The resultant difference signal is applied to the Output Amplifier stage. Here the signal is further amplified and applied via pins 17 and 21 of the interconnecting plug to the crt vertical deflection plates in the oscilloscope.

In conventional-amplifier mode of operation the overall gain of the Type 3A7 is about 23,000. This amount of gain produces about 23 volts of signal at the deflection plates for each 1 mV of signal applied to the input connector (Nominal vertical sensitivity of the crt used in the 560-Series oscilloscope is about 23 V/div of deflection.)

A vertical signal is taken off from the Output Amplifier stage and applied to the Sig/Trig Takeoff Amplifier. In this stage the signal is amplified to a sufficient amplitude (about 2.5V/div) for the output to be applied via pin 11 of the interconnecting plug to the trigger circuitry in the time-base plug-in unit.

The dc component of the signal, which includes the dc-positioning voltage, drives the Position Indicators stage. Position indicator lights mounted on the Type 3A7 front panel indicate whether the trace is above or below the art screen when the trace is driven off the screen.

Throughout the following discussion refer to both the block and circuit diagrams in Section 8.

DETAILED-CIRCUIT DESCRIPTION

Comparison Voltage Supply

To make the Type 3A7 operate at its specified comparison voltage accuracy, the comparison voltage (V_c) supply must maintain a constant voltage independent of environmental temperature changes and differences in the regulated power supply voltages between one oscilloscope and another. To obtain this high accuracy the comparison voltage is derived from a precision diode reference element D401. This element is a special device which compensates itself for temperature. Its output is nominally 11.7 volts and the voltage remains constant within 0.001% per degree Celsius change.

When the V_c RANGE switch SW410 is set to the +11 or +1.1 position, D401 cathode connects through R401 to the +125-volt supply to provide the plus (+) comparison voltage to the V_c output circuitry. D401 anode connects

Operating Instruction-Type 3A7

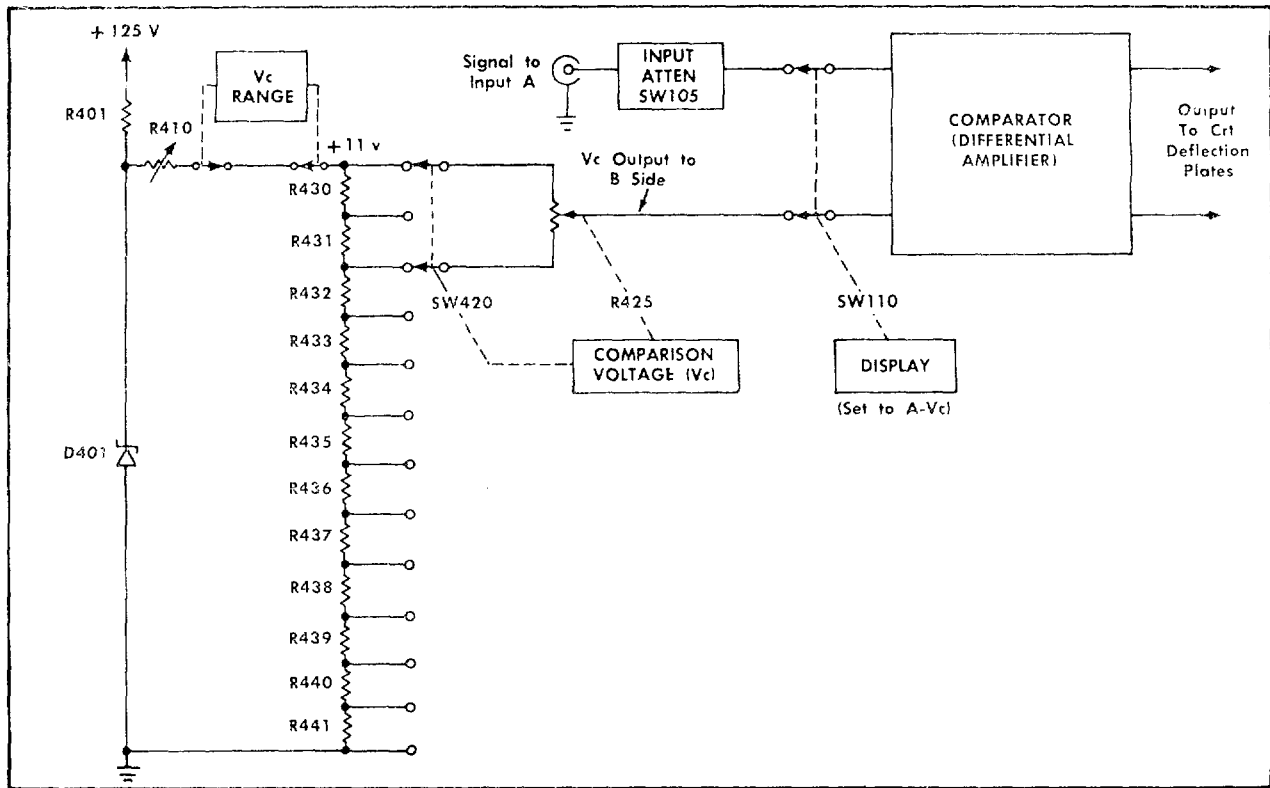

Fig. 3-1. Simplified diagram of the comparison voltage circuit and how it is connected to the amplifier for A-Vc differential-comparator mode of operation.

to ground. R401 sets the current through D401 so the element can operate in its temperature-stable region. The Vc output circuit, composed of the COMPARISON VOLTAGE switch SW420 and variable control R425 with associated components, make up the normal load for D401.

When the Vc RANGE switch is set to 0, D401 cathode connects to ground and the anode connects through R403 to the -100-volt supply. The Vc output circuit is disconnected from D401. To take the place of the Vc output circuit, R406 is connected across D401 to simulate normal loading for the reference element.

When the Vc RANGE switch is set to -11 or -1.1, D401 cathode connects to ground and its anode connects through R403 to the -100-volt supply. This is the same as the 0 position except the simulated load resistor R406 is now disconnected, and in its place, the normal Vc output load is connected across D401 to supply the minus (-) comparison voltages.

Comparison Voltage Range

The comparison voltage range circuitry consists of R408, R410, R413 and R415 which are connected to the various contacts on the Vc RANGE switch. This portion of the Vc RANGE switch selects the range of comparison voltage applied to the COMPARISON VOLTAGE control.

Resistor R408 is selected for value when paired with D401. The reference element is a 5% diode and so a value for

R408 is chosen that will set the comparison voltage well within the adjustment range of the Vc CAL control R410.

The Vc CAL control is small in value to minimize effect of the control's temperature coefficient and to provide adequate resolution for setting the comparison voltage accurately. The control is adjusted so the comparison voltage is exactly +11 volts as measured with a non-loading voltmeter connected between the Vc OUT jack and ground.

As a necessary condition prior to adjusting R410, the Vc RANGE switch is set to +11 and the COMPARISON VOLTAGE combination control to 11 (10-10-0). This condition essentially places the Vc OUT jack at the same voltage level as that obtained between the top end of R430 (TP420 on the Comparison Voltage Generator diagram) and ground.

When the Vc RANGE switch is set to +1.1 or -1.1, a precision divider network consisting of R413 and R415 reduces the comparison voltage to 10:1 so the voltage is exactly 1.1 volt as measured between the Vc OUT jack and ground with the COMPARISON VOLTAGE control set to 10-10-0 which, in this case, is 1.10.

When the Vc RANGE switch is set to the 0 position, no comparison voltage is applied to the 10:1 divider and Vc output circuit.

The use of ±11- and ±1.1-volt ranges instead of the usual ±10- and ±1-volt ranges extends the comparison voltage ranges by 10%. This permits using the 10% increased range for overlapping coverages between the

Circuit Description-Type 3A7

usual ranges and to extend the highest range. For example, when using the 1.1-volt range, the COMPARISON VOLTAGE control can be used at the 1-volt level to make measurements without having to switch to the next higher range.

Comparison Voltage Output Circuit

The comparison voltage output circuit (see Fig. 3-1 and the Switching Diagram) is composed of the COMPARISON VOLTAGE combination control SW420 and R425 with associated circuitry. The COMPARISON VOLTAGE control is a combination of two controls: (1) Switch SW420 selects the first digit within the range set by the Vc RANGE switch, and (2) the 10-turn potentiometer R425 selects the remaining digits.

A string of twelve resistors, R430 through R441, makes up the main divider. This portion of the Vc output circuitry could be called a hybrid Kelvin-Varley bridge. The comparison voltage is applied to the top end of the divider and the bottom end is grounded. A shunt divider consisting of R422, R423, and R425 is connected across two of the resistors in the main divider by means of SW420. The equivalent resistance of the shunted portion of the main divider is equal to 1 k.

The TRACKING control R423 provides the means for setting the shunt resistance accurately. Thus, the main divider is actually divided into eleven equal divisions of 1 k each. If the Vc RANGE switch is set to +11 or -11, for example, there will be one-volt drop across each 1-k resistor.

Switch SW420 has 11 positions to permit switching the shunt divider across two resistors at a time along the string of resistors in the main divider. Each position corresponds to one digit of voltage. Variable control R425 in the shunt circuit is the vernier control for dividing the comparison voltage further so the smaller divisions of the voltage can be resolved. For example, if the Vc RANGE switch is set to +11, SW420 is set to 6, and R425 is set to 1-25, the comparison voltage reading is +6.125 volts.

The comparison voltage set by SW420 and R425 is applied through the DISPLAY switch SW110 to the Type 3A7 amplifier. In this mode of operation the amplifier operates as a differential comparator. The comparison voltage is also applied to the front-panel Vc OUT jack. This jack permits connecting a nulling-type meter or infinite-impedance-type meter to this point so the voltage can be monitored. The output voltage at the jack is very limited in current output; therefore, meters which draw negligible current should be used to prevent measurement errors. For further information refer to the topic "Vc OUT Jack" in the Operating Instructions section of this manual.

In the description that follows, assume the signal is applied to the input A connector and the AC-DC-GND switch on the B side of the amplifier is set to GND for conventional-amplifier operation. Since both sides of the amplifier are similar, the description attempts to follow the signal path through the A side in more detail than the B side.

AC-DC-GND Switch

With a signal applied to the input A connector, the signal must pass through the AC-DC-GND switch SW101, the INPUT ATTEN switch SW105, and the DISPLAY switch SW110 to get

to the grid of V113.

When the AC-DC-GND switch SW101 is set to AC, the signal is ac-coupled through C101 to the INPUT ATTEN switch SW105. When SW101 is set to DC, input coupling capacitor C101 is bypassed with a direct connection. Thus, the signal is dc-coupled to SW105. If SW101 is set to GND, the signal is disconnected and the input side of SW105 is grounded to prevent stray signal pickup. In addition, the GND position permits operating the Type 3A7 as a conventional amplifier using input B. With the A input grounded, for example, the signal is applied to the input B connector and SW201 is set to AC or DC to couple the signal to the amplifier.

Input Attenuation

The INPUT ATTEN switches SW105 and SW205 are identical five-position switches. They are gear driven so they are switched together and are at matched attenuator ranges at all times. When SW105 in the A side is set to $R \approx \infty$, the signal is applied straight through the INPUT ATTEN switch to the grid of V113 and there is no 1-megohm resistor connected from grid to ground. Instead, the resistance path is through the external-load resistance to ground. For this to be accomplished, the AC-DC-GND switch SW101 must be set to DC.

When the INPUT ATTEN switch is set to 1, there is no attenuation of the signal. The grid-to-ground resistance is R105A and R105B connected in series. Resistor R105B is adjusted so the input resistance matches the 10X input resistance.

For the 10, 100 and 1000 settings of the INPUT ATTEN switch, attenuator networks are individually switched into the circuit to attenuate the signal before it is applied to the Input A CF stage. The attenuator networks are frequency-compensated RC voltage dividers. At dc and low frequencies the dividers are resistive because the impedance of the capacitors is high and their effect on the circuit negligible. As the frequency of the input signal increases, however, the impedance of the capacitors decreases and their effect in the circuit becomes more pronounced.

When the INPUT ATTEN switch is set to 10, for example, R106E adjusts the dc attenuator ratio so it is exactly 10 to 1. For higher frequencies, C106C, a coarse adjustment, and C106E, a fine adjustment, are used to frequency-compensate the divider so the capacitive reactance ratio is equal to the resistance ratio. Adjustments in the input B 10X attenuator are adjusted in a similar manner to that described for input A. If differential-amplifier operation is used to adjust the input B attenuator, then the B attenuator can be made to match the A attenuator, and optimum common-mode rejection is achieved.

Variable capacitor C106B in the 10X attenuator is adjusted so the input RC of the attenuator is 20 pF times 1 M Ω . When making the adjustment, an Input Time-Constant Standardizer is used as the reference. Thus, an attenuator probe, when connected to the input connector and properly adjusted, will work into the same input time constant regardless of the INPUT ATTEN switch position.

The DISPLAY switch SW110 connects one or the other input, or both in the A-B position, to the Input CF stages.

Circuit Description-Type 3A7

In the A-Vc position the A input signal is applied to the grid of V113 and the comparison voltage is applied to the grid of V213. A normal or upright display will be obtained. If a + polarity voltage is applied to input A, the trace moves upward on the crt. Similarly, a + polarity comparison voltage applied to the B side adds differentially in the Type 3A7 amplifier and drives the trace downward. As a result, the trace can be made to return to its original position to obtain a null. When a null is obtained, the equivalent comparison voltage equals the input A voltage.

In the Vc-B position, the B input signal is applied to the grid of V213 and the comparison voltage is applied to V113 grid. The display will be inverted; that is, if a + polarity voltage is applied to the B input, the trace moves downward. To obtain a null, a + polarity comparison voltage is applied to the A side to move the trace upward to its original position.

In the A-B position, the Type 3A7 operates as a differential amplifier. Both inputs are active and difference between the A and B signals is displayed. In this mode of operation the comparison voltage is not used, but it is available at the Vc OUT connector.

Input Cathode Follower Stages

The Type 3A7 contains two input cathode followers. For the A side it is the Input A CF consisting of V113, V124A, V134A and associated circuitry. For the B side it is the Input B CF consisting of V213, V224A, V134B and associated circuitry.

The wide dynamic operating range of the Type 3A7 requires the use of constant-current and bootstrap circuits for linear operation and to minimize dc shift. The current source of longtail for V113 is through V134A and R136 to the -100-volt supply. The term longtail applies to a tube circuit in which the cathode returns to a voltage that is well below the grid-return voltage level. For a longtail transistor circuit, the emitter returns to the supply voltage through a large resistance. Divider network R129, R130 and R134 sets the current for V113. The DC BAL control R130 is adjusted so the dc differences between the two cathode followers are minimized for proper dc balance.

The plate of V113 is bootstrapped by V124A. The bootstrapping action is through a compensated divider from the cathode of V113 to +300 volts. The divider consists of R122 and R123 compensated by C120 and C122. Bootstrapping minimizes V113 changes in characteristics by keeping the plate-to-cathode voltage changes as small as possible with large signal swings.

Diode D110 protects V113 against extreme turn-on conditions such as those encountered when plugging the Type 3A7 into a turned-on oscilloscope. In such a condition the diode conducts and limits the grid-to-cathode positive-bias voltage to about 0.6 volt until V113 starts conducting normally. Resistor R110, located in V113 grid circuit dampens most oscillations that might result from connecting on inductance to the input A connector.

The DIFF BAL control R216, in conjunction with R114 and R214, serves to load the cathodes of V124A and V224A so both sides can be balanced. By adjusting R26, the gain of V124A for example, can be made to decrease while the gain of

V224A increases. This will differentially adjust the gain 314 of V124A and V224A to make up for some of the small differences in the characteristics of V113 and V213. The gains of V113 and V213 must be the same to obtain optimum common-mode rejection in the stage that follows. Typical voltage gain of the Input CF stage is about X1 for signals up to ± 15 volts in amplitude.

To take care of any remaining small differences in the characteristics of V113 and V213, a CF LOAD BALANCE adjustment R212 is provided. This control differentially adjusts the loading on the cathodes. When carefully adjusted at the same time as the DIFF BAL control, rejection of common-mode signals by the Comparator stage can be further optimized.

Comparator

A signal at the cathode of V113 is coupled through D124A to the base of Q144A in the Comparator stage. This stage consists of Q144A and V124B with associated circuitry on one side, and Q144B and V224B with associated circuitry on the other side. Transistor Q234 is the current source for the stage.

The tube-and-transistor combination forms a hybrid circuit which has a very high output impedance. Voltage gain of the Comparator stage is about 15 per side at a sensitivity of 1 mV/div for single and differential signals.

The Comparator stage is able to handle common-mode signal up to ± 15 volts in amplitude. Any current change in the circuit resulting from common-mode signals is minimized by the high output impedance of the stage. There is virtually no differential gain for common-mode signals.

Transistors Q144A and Q144B are the comparators in the circuit because they divide up the current passing through them. The current through each transistor is dependent on the difference voltage between the bases.

Transistor Q234 is the current source for the comparator transistors Q144A and Q144B. In addition, this transistor supplies current to diodes D124A and D124B. The diodes serve to disconnect the Comparator stage from the Input CF if a large signal overdrives the Input CF stage. For example, if input B is grounded and a large positive-going signal is applied to the input A connector, V113 follows the signal in a positive direction and conduction through D124A increases. The emitters of Q144A and Q144B follow in a positive direction; the base of Q144B and hence the cathode of D124B, also rises.

When D124B cathode rises high enough for the diode to be back biased, D124B disconnects the Comparator stage from the Input B CF to prevent damaging Q144A and Q144B. The result will be the same if a large negative-going signal is applied to input B when input A is grounded.

Gain of the stage is set by rotating the VARIABLE control R245 clockwise to its smallest value of resistance (CAL position) and by adjusting the AMP CAL control R244 to get the correct display amplitude on the crt. When the VARIABLE control is turned fully counterclockwise, gain is decreased by a factor of at least 2.5. However, this ratio is actually greater than 2.5 to 1 due to SW245. When the control is turned a few degrees counterclockwise from the CAL position, SW245 closes and shorts out R244. Gain increases

Circuit Description-Type 3A7

somewhat, thus providing overlapping coverage between the calibrated MILLIVOLTS/DIV switch positions.

In the emitter circuit of Q144A, network C143 and R143 improves the transient-response of the stage. Parasitic-suppressor resistor R147, connected between the emitter of Q144A and the grid of V124B serves to bootstrap the collector voltage of Q144A. Therefore, the grid-to-cathode bias of V124B furnishes the emitter-to-collector bias for Q144A. This is a similar circuit to the one used in the Input A CF stage. The AMP BAL control R233 balances the currents through the two sides of the Comparator stage. To equalize the currents, the AMP BAL control is adjusted for minimum trace shift as the MILLIVOLTS/DIV switch is rotated from the 50 position to 1.

When the MILLIVOLTS/DIV switch is set to 1, the load resistor for one side is R149 and for the other side it is R249. This makes the load equal to 3k differentially. To decrease the gain in a 1-2-5 sequence, R150A through R150E are used as shunt resistors. Thus, sensitivity of the Type 3A7 can be changed from 1 mV/div to 50 mV/div. In differential-comparator mode of operation this 50-to-1 gain range is useful as a vertical magnifier for the signal. The vertical size of the waveform changes but not the comparison voltage measurement.

Diodes D148 and D150 improve the overdrive recovery of the Type 3A7. A positive-going overdrive signal, for example, causes D150 to conduct. Thus, D150 limits the signal swing at the base of Q154 with respect to the base of Q254. Limiting the signal in this manner prevents overdriving the Output Amplifier.

Output Amplifier

The Output Amplifier stage consists of Q154 and Q164 as a feedback amplifier for one side. The feedback amplifier for the other side is Q254 and Q264. In addition to the feedback amplifier, there is a hybrid amplifier consisting of Q174 and V174 on one side. For the other side the hybrid amplifier is Q274 and V274.

The first amplifier to be described is Q154 and Q164 with associated circuitry. These transistors are connected in a feedback arrangement to provide an overall voltage gain of about 40 per side. Feedback is provided by R155 connected from the collector of Q164 to the emitter of Q154. Capacitors C155 and C255 improve the transient response.

The DRIVER DC LEVEL control R260 establishes the collector voltages of Q164 and Q264 through Q154 and Q254. To adjust the control, the DC BAL R130 and AMP BAL R233 are first set to midrange and the FIL BAL control R338 is adjusted to center the trace. Then, the DRIVER DC LEVEL control is adjusted to obtain a +59-volt reading on the voltmeter connected between TP264 and ground.

Normal vertical positioning of the trace is accomplished by rotating the POSITION control R258. The positioning range of this control is about ± 7 crt divisions. As the control is rotated in either direction from its midrange position, it shunts more current to one transistor or the other. The paths for the positioning currents are through R157 and R257 to the emitters of Q154 and Q254.

To give the POSITION control equal range above and below graticule center, POSITION RANGE control R253 is provided. To adjust R253 the POSITION control must first be

set to midrange. Then R253 is adjusted so the trace coincides with graticule center. Proper adjustment of the control, however, depends on correct adjustment of the DRIVER DC LEVEL and other dc balance adjustments.

The second amplifier in the Output Amplifier is Q174 and V174 with associated circuitry on one side; Q27 and V274 with associated circuitry comprises the other side. Transistors Q174 and Q274 are emitter-coupled through R279 and R276. Longtail current is supplied through R277. The transistors are biased in the same manner as the Comparator transistors Q144A and Q144B; that is, the grid-cathode bias of tubes V174 and V274 furnishes the collector bias. Gain of the stage is about 40.

Inductors L169 and L170 provide high-frequency peaking in the output circuit. Collector load resistor R170 returns through a decoupling network C314 and R314 to the +300-volt supply. R314 sets the output dc level applied to the plate of V174 and pin 21 of the interconnecting plug. Components C280, C281, L280 and R280 provide emitter peaking for the stage.

Diodes D168 and D278 work in conjunction with R173 and R273 respectively to provide fast recovery on overdrive signals. Under normal conditions, both diodes are conducting. But, for example, if a negative-going overdrive signal is applied to the base of Q174, diode D168 back biases. Meanwhile, D278 remains forward biased because the signal at the base of Q274 is positive-going.

With D168 back biased in the foregoing example, about 3 mA of longtail current flows through R168, Q174 and R173 to tie the voltage down at the junction of Q174 collector and V174 cathode while the overdrive signal is present. If D168 and R173 were not in the circuit, Q174 would be driven into cutoff and its collector would float at an arbitrary voltage.

Output signal polarity at pin 21 is the same as the polarity of the signal applied to the input A connector. At pin 17 the signal polarity is opposite to the one at pin 21 and the input A connector.

Sig/Trig Takeoff

The Sig/Trig Takeoff Amplifier stage is a one-transistor Q284 comparator circuit and a feedback operational-type of amplifier consisting of Q294 and associated circuitry.

Comparator transistor Q284 is connected in the emitter circuit of Q174 and Q274 where there is low impedance and a fairly large voltage swing. The signal at the emitter of Q174 is applied through R281 to the emitter of Q284 and the signal at the emitter of Q274 is applied through D282 to the base of Q284. Any voltage difference between the emitters of Q174 and Q274 causes a current change through Q284. Diode D282 equalizes the base-emitter drop and provides temperature compensation for Q284.

Zener diode D286 and its bypass capacitor C286 establish the operating voltage for Q284. In the event Q284 is driven into cut off, diode D292 conducts to prevent exceeding the collector voltage rating of Q284. An adjustment, SIG/TRIG DC LEVEL control R288, sets the dc level at pin 11 of the interconnecting plug. To adjust the control, set the POSITION control so the trace is centered on the crt and then adjust the SIG/TRIG DC LEVEL control so the voltage is zero at TP294 under no-signal conditions.

Circuit Description-Type 3A7

The signal current at the anode of D286 is applied to the base of Q294. Resistor R290 provides the feedback so Q294 can function as an operational-type amplifier. To increase the operating range of Q294, the emitter is returned to the anode of Zener diode D330. The constant voltage at this point, set by the Zener, is nominally 5.6 volts more negative than the -12.2-volt supply. A decoupling network, C292 and R292, in the Q294 emitter circuit prevents signal currents from being coupled through the -12.2-volt supply into other parts of the instrument.

The output signal at the collector of Q294 is applied to pin 11 of the interconnecting plug and to the base of Q304. At pin 11 the amplitude of the signal is about 2.5 volts for every division of deflection on the crt. This signal, which includes a dc-positioning component, is applied via pin 11 to the time-base plug-in unit to operate the trigger circuitry. Output signal polarity at pin 11 is the same as previously described for pin 21.

Position Indicators

The signal at the collector of Q294 is applied to the Position Indicators stage. In this stage there is one transistor, Q304, which operates as a three-position switch for the neon position indicators B300 and B302. The three-positions are: (1) B300 and B302 off, (2) B300 on, B302 off; (3) B300 off and B302 on.

When the trace coincides with graticule center, Q304 is at or near the center of its conduction range and the neons are extinguished. As the trace is positioned upward, Q304 goes into saturation and B300 "up" neon turns on through R300 to the +125-volt supply. As the trace is positioned downward through center screen, Q304 conduction decreases to normal and B300 turns off. During all this action B302 is off.

When the trace positioned downward so it is located in the lower half of the screen or below the screen, Q304 turns off and B302 "down" neon turns on through R304 to the +125-volt supply. B300, meanwhile, remains off.

Capacitor C304, connected between Q284 emitter and base, bypasses the ac component so the dc component of the signal is the main drive for Q304 and the neon position indicators.

+ 24-Volt Power Supply

The +24-volt (nominal) power is obtained from Zener diode D324. This diode is connected through R324 to the +125-volt supply. The +24 volts from the Zener is applied to the center arm of the DIFF BAL control R216. Elevating the control to +24 volts reduces the loading effect on V124A and V224A by reducing the standing current. Since the arm of R216 usually ends up being near center when properly adjusted, current drawn through R114 and R214 is very small.

Heater Circuit

Direct current is used to operate the heaters of V113, V213, V134, V124 and V224 in the Type 3A7. A -12.2-volt dc source (rather than ac) is used for these heaters to avoid the possibility of cathode modulation at line frequency, and changes in heater voltage due to line-voltage fluctuations.

Connected between the heaters of V113 and V213 is a FIL BAL control R338. This control enables the cathode temperature of V113 and V213 to be differentially adjusted. As a result, tubes that vary considerably in characteristics can be made to operate at about the same bias. In addition, the control enables the DC BAL control R212 to have sufficient range. Thus, the FIL BAL control acts as a very coarse dc balance adjustment and the DC BAL control serves as a fine adjustment.

Resistor R336 in the dc heater circuit provides the proper voltage drop to operate V134 heater.

The heaters of tubes V174 and V274 are connected to 6.3 volts ac via pins 1 and 2 of the interconnecting plug. Since these tubes operate at much higher signal levels, heater voltage fluctuations do not affect the operation of the Type 3A7.

Shunt Resistor R342

Resistor R342, connected between pin 22 and ground, is a shunt resistor for the -100-volt supply in the oscilloscope. The resistor shunts the series regulator tube so the supply regulates properly within the line voltage operating limits.

SECTION 4 MAINTENANCE

PREVENTIVE MAINTENANCE

Cleaning the Front Panel

Loose dust may be removed with a cloth and a dry paint brush. Water and mild detergents such as Kelite or Spray White may be used.

CAUTION

Avoid the use of chemical cleaning agents which might damage the plastics used in this unit. Avoid chemicals such as benzene, toluene, xylene, acetone, or similar solvents.

Cleaning the Interior

Cleaning the interior of the unit should precede calibration since the cleaning process could alter the setting of certain calibration adjustments.

To clean the interior, use dry low-velocity compressed air to blow off the accumulated dust. Very high-velocity air stream should be avoided to prevent damage to some of the components. Hardened dirt can be removed with a soft, dry paint brush, cotton-tipped swab or cloth dampened with a water and mild detergent solution. Avoid the use of chemical cleaning agents that might damage the plastic parts.

Visual Inspection

The unit should be inspected occasionally for such defects as poor connections, broken or damaged ceramic terminal strips, improperly seated tubes or transistors, and heat damaged parts. The remedy for most visible defects is obvious. But, damage from overheating is usually a symptom of less obvious trouble; and unless the cause is determined before parts are replaced, the damage may be repeated.

COMPARISON VOLTAGE 10-Turn Dial Check

If the reference mark located above the 10-turn dial knob has moved from its original perpendicular position, it can be repositioned as follows:

1. Using a 0.050-inch hexagonal wrench, remove the COMPARISON VOLTAGE 10-turn dial knob (see Fig. 4-1).
2. Make sure the 3/8-inch nuts holding the bushing are tight.
3. Use a spanner wrench to slightly loosen the mounting nut which holds the 10-turn dial assembly. Use the finger tips to realign the assembly so the reference mark is perpendicular. Hold the assembly to keep it from turning, and tighten the mounting nut.

4. Re-install the 10-turn dial knob. Be sure the knob reads 0-0 when the 10-turn potentiometer shaft is turned to its fully counterclockwise position.

Tube and Transistor Checks

Periodic preventive maintenance checks on the tubes and transistors used in the unit are not recommended. The circuits within the unit generally provide the most satisfactory means of checking tube or transistor usability. Performance of the circuits is thoroughly checked during recalibration so that substandard tubes and transistors will usually be detected at that time. More details are provided in the Troubleshooting Information portion of this section.

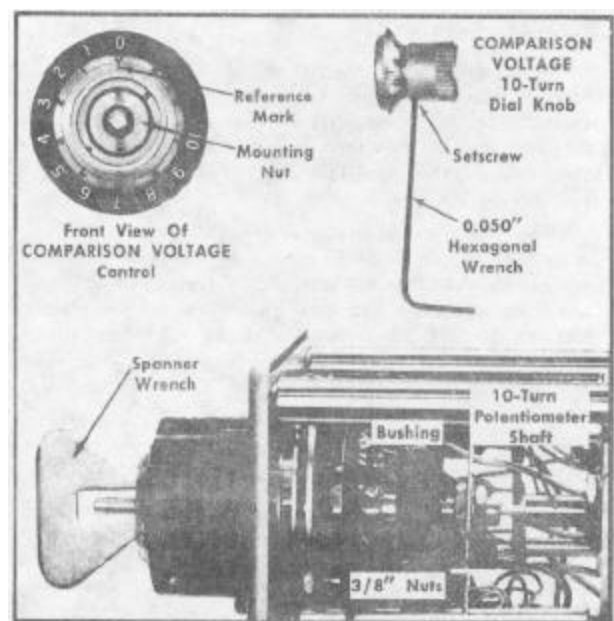

Fig. 4-1. Aligning the COMPARISON VOLTAGE 10-turn dial assembly so the reference mark is perpendicular.

Recalibration

To insure accurate measurements, the Type 3A7 calibration should be checked after each 500 hours of operation or every six months if used intermittently. Complete calibration instructions are contained in Section 5.

The calibration procedure can be helpful in isolating major troubles in the unit. Moreover, minor troubles not apparent during regular operation may be revealed and corrected during calibration.

Maintenance-Type 3A7**CORRECTIVE MAINTENANCE****General Information**

Replacement of some parts in the unit should be done by following a definite procedure. Some procedures, such as soldering and replacing ceramic strips, are outlined in this portion of the manual.

Many electrical components are mounted in a particular way to reduce or control stray capacitance and inductance. When selecting replacement parts, it is important to remember that the physical size and shape of a component may affect its performance at high frequencies. When a repair is made, recalibration of that portion of the circuit should be checked. Refer to the Calibration procedure in Section 5 and perform the applicable calibration steps.

Standard Parts

See page 6-0.1 for parts ordering information.

Special Parts

See Parts Ordering information and Special Notes and Symbols on page 6-0.1.

Soldering

Ceramic Terminal Strips. In the production of Tektronix instruments a silver-bearing solder is used to establish a bond to the ceramic terminal strips. This bond can be broken by repeated use of ordinary tin-lead solder, or by excessive heating of the terminal strip with a soldering iron. Occasional use of ordinary 60/40 solder will not break the bond unless excessive heat is applied. Use a 40-to 75-watt soldering iron with a 1/8-inch wide chisel-shaped tip.

If you are responsible for the maintenance of Tektronix instruments it is advisable to have a stock of solder, containing about 3% silver. This type of solder is used in printed circuitry, and is generally available locally.

The following precautions should be observed when removing or replacing components mounted on the ceramic strips:

1. Use a hot iron for a short time. Apply only enough heat to make the solder flow freely.
2. Maintain a clean, properly-tinned tip.
3. Avoid putting pressure on the ceramic terminal strip.
4. Do not attempt to fill the terminal strip notch with solder; use only enough solder to cover the wires adequately.

Metal Terminals. When soldering to metal terminals (e.g., interconnecting plug pins, switch terminals, potentiometers, etc.), ordinary 60/40 solder can be used. The soldering iron should have a 60- to 75-watt rating with a 1/8-inch wide chisel-shaped tip to get into the tight places.

Observe the following precautions when soldering to metal terminals.

1. Apply only enough heat to make the solder flow freely.
2. If a wire extends beyond the solder joint clip the excess close to the joint.
3. Apply only enough solder to form a solid connection. Excess solder may impair the function of the part.

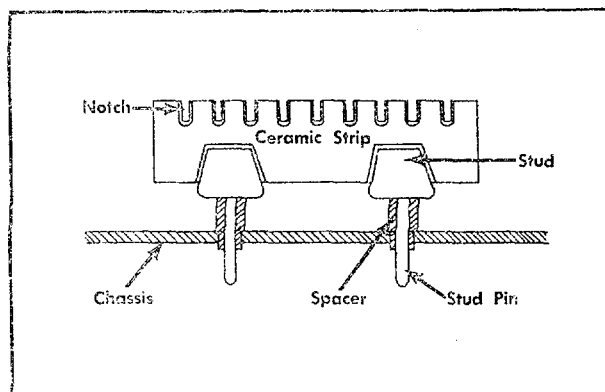

Fig. 4-2. Ceramic terminal strip assembly.

Replacement of Ceramic Terminal Strips

Fig. 4-2 shows an assembled ceramic terminal strip.

Replacement strips with studs attached are supplied under a single part number, and spacers under another number. The original spacers may be re-used if undamaged.

Usually a strip can be pried out of the chassis or pulled out with a pair of pliers. Or, a hammer and punch may be used to drive out the studs from the opposite side of the chassis.

When the damaged strip has been removed, place new spacers in the chassis holes. Then, carefully force the studs of the new strip into the spacers until they are completely seated. If necessary, use a soft-faced mallet, tapping lightly directly over the stud area of the strip.

Removing and Replacing Switches

If either of the AC-DC-GND switches is defective, remove and replace the switch. Use normal care in disconnecting and reconnecting the leads. To remove the nut that mounts the switch to the panel, use a 1-inch open end wrench which is ground down for clearance.

Single wafers on the INPUT ATTEN, DISPLAY and MILLIVOLTS/DIV switches are not normally replaced. If any of

these switches are defective, the entire switch should be replaced. The switches can be ordered through your Tektronix Field Engineer either unwired or wired, as desired. Refer to the Electrical Parts List to find the unwired and wired switch part numbers.

CAUTION

When disconnecting or connecting leads to a wafer-type switch, do not let solder flow around and beyond the rivet on the switch terminal. Excessive solder can destroy the spring tension of the contact. When soldering to contacts mounted on plastic (delrin) wafers such as those on the INPUT ATTEN and DISPLAY switches, do not use too much heat. Otherwise, the plastic wafer will soften and loosen the riveted contact.

TROUBLESHOOTING INFORMATION

Introduction

In the event a trouble develops use the information in this portion of the manual to more efficiently troubleshoot the Type 3A7. The information starts with preliminary checks to make, and then advances to detailed circuit troubleshooting.

Front-Panel Controls

Before troubleshooting, double-check the front-panel controls for proper settings. Also, check the front-panel screwdriver adjustments to determine whether their settings are proper. This is important since symptoms caused by incorrect front-panel control settings are not described in this section of the manual.

If you are in doubt as to the proper settings of the controls or their function, refer to the Operating Instructions section. If the front-panel controls are properly set and you find that a trouble definitely exists, first check to determine whether the trouble is in the oscilloscope or the Type 3A7.

Type 3A7 or Oscilloscope

When following a troubleshooting procedure, it is assumed that the oscilloscope used with the Type 3A7 is operating normally. Since this is not always the case, check the operation of the oscilloscope before attempting to troubleshoot the Type 3A7.

Troubles occurring in the oscilloscope can usually be detected by substituting another plug-in unit for the Type 3A7.

NOTE

Be sure the proper line voltage is applied to the oscilloscope used with the Type 3A7.

If the Type 3A7 is definitely at fault rather than the oscilloscope, make a careful operational check of the Type 3A7. Carefully note the effect that each front-panel control has on the symptom. By analyzing such effects, you can sometimes isolate a trouble to either a defective control or circuits

containing the trouble. The normal or abnormal operation of each control should indicate the checks that need to be made.

The remainder of this section deals with troubleshooting aid information. Table 4-2, for example, gives the interconnecting-plug to ground resistances. Table 4-3 is a list of symptoms that provide a guide for isolating a trouble to a certain stage or circuit.

A step-by-step method for checking and adjusting the Type 3A7 is given in the Calibration section. The calibration procedure can be used to check the operational standards of the unit. Any deficiency that shows up while performing the steps can lead you to the area at fault and the possible causes.

Tube and Transistor Substitution

Tubes and transistors should not be replaced unless actually defective. However, temporary substitution is often the fastest and best way to detect a defective tube or transistor.

Before substituting a tube or transistor, it is suggested that circuit conditions be checked to be certain that an exact replacement tube or transistor will not be subject to damage. In some cases, these checks will also show whether or not the tube or transistor is at fault. Fig. 4-3 shows the wiring side of the nuvistor and transistor sockets as an aid to circuit tracing.

NOTE

Turn off the indicator unit power before replacing tubes or transistors. When replacing Q144, be sure the metal indexing tab faces to the rear of the unit when inserting the transistor in the socket. The emitter leads on this transistor are located at the opposite end from the tab (see Fig. 4-3).

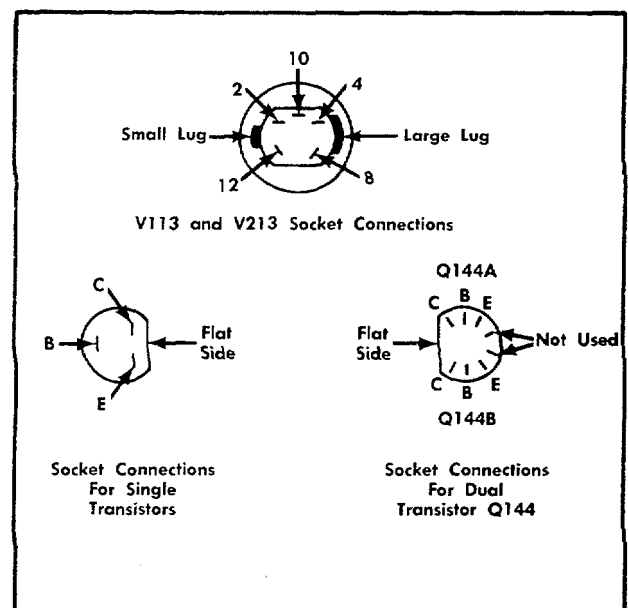

Fig. 4-3. Bottom (wiring) view of the nuvistor and translator sockets used in the Type 3A7. Index tab Q144 should face flat side of socket.

Maintenance-Type 3A7

When circuit conditions are known to be safe, install a tube or transistor of the same type which is known to be good and then check the unit for proper operation. If the original tube or transistor is thus proved acceptable, return it to the socket from which it came to avoid unnecessary recalibration.

Diagrams

Block and circuit diagrams are contained in the pullout pages in Section 8. The circuit diagrams contain component circuit numbers, voltages and waveforms. Conditions under which the voltages and waveforms were taken are also indicated on the inside portion of the Differential Amplifier schematic pullout page.

Coding of Switch Wafers

Switch wafers shown on the circuit diagrams are coded to indicate the physical location of the wafer on the actual switches. The number portion of the code refers to the wafer number of the switch assembly. Wafers are numbered from the first wafer behind the driven end of the shaft to the last wafer.

The letters F and R indicate whether the front or rear of the wafer is used to perform the particular switching function. For example, 2R of the MILLIVOLTS/DIV switch is the second wafer when counting back from the driven end; the letter R refers to the rear side of the wafer.

Cable Color Coding

All wiring in the Type 3A7 is color coded to facilitate circuit tracing. The power-supply wires connected to the Type 3A7 interconnecting plug and the divider voltages using cable wiring are all identified by the color code that follows. The widest stripe identifies the first color in the code.

Supply Voltage	Cable Color-Code
+300 V	Orange/green/dark-brown on white
+125 V	Dark-brown/red/red on white
+125 V (decoupled)	Dark-brown on white
+81 V	Purple/green/black on white
+24 V	Dark-brown/green/black on white
-12.2 V	Dark-brown/red/black on tan
-100 V	Dark-brown/black/dark-brown on tan
63 VAC	Blue/orange on white: blue/yellow on white

Resistor Color Coding

Some stable metal-film resistors are used in this instrument. These resistors can be identified by their gray body color. If a metal-film resistor has a value indicated by three significant figures and a multiplier, it will be color coded according to the EIA standard. If it has a value indicated by four significant figures and a multiplier, the value will be printed on the body of the resistor. For example, a 333-k resistor will

be color coded, but a 333.5-k resistor will have its value printed on the resistor body. The color-code sequence is shown in Fig. 4-4 and Table 4-1.

Composition resistors are color coded according to the EIA standard resistor color code.

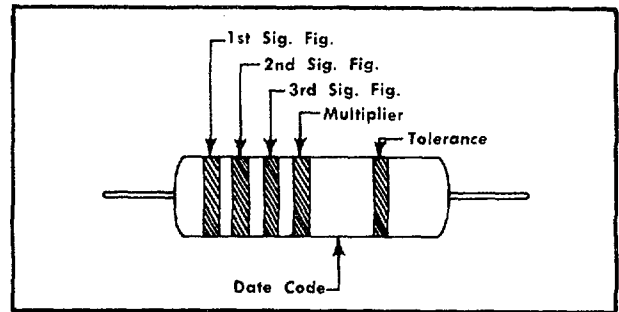

Fig. 4-4. Standard EIA color code for metal-film resistors.

TABLE 4-1

Color-Code Sequence					
Color	1st Sig. Fig.	2nd Sig. Fig.	3rd Sig. Fig.	Multiplier	(±) % Tolerance
Black	0	0	0	1	—
Brown	1	1	1	10	1
Red	2	2	2	100	2
Orange	3	3	3	1,000	—
Yellow	4	4	4	10,000	—
Green	5	5	5	100,000	0.50
Blue	6	6	6	1,000,000	0.25
Violet	7	7	7	10,000,000	0.10
Gray	8	8	8	100,000,000	0.05
White	9	9	9	1,000,000,000	—
Gold	—	—	—	0.1	5
Silver	—	—	—	0.01	—
No Color	—	—	—	—	-10

Test Equipment

When preparing to circuit troubleshoot the Type 3A7, you may find useful some of the equipment described here.

1. Transistor Tester

Description: Tektronix Type 575 Transistor Curve Tracer.

Purpose: Test transistors and diodes used in the Type 3A7.

2. VOM

Description 20,000 Ω/V dc. Equipped with test prods that can be used in tight places without causing accidental shorts.

Purpose: Precision and general-purpose use. Can also be used to check transistors and diodes if used with care. When checking semiconductors, use an ohmmeter range (usually RX1K) that delivers less than 2 mA of current at full deflection. Preferably, use a good transistor and diode tester in place of the VOM.

3. Test Oscilloscope

Description: Bandwidth, dc to 300 kHz or better. Calibrated vertical deflection factors down to 5 mV/div. Input resistance, 1 megohm without a 10X probe; 10 megohms with a 10X probe.

Purpose: For low-frequency signal-tracing the amplifier stages.

4. Flexible Cable Plug-In Extension

Description: 30 inches long, Tektronix Part No. 012-0066-00.

Purpose: Permits operating the Type 3A7 out of the oscilloscope plug-in compartment for better accessibility during troubleshooting.

5. BNC Coaxial Cables (two required)

Description: 42 inches long equipped with BNC plug connectors on each end. Tektronix Part No. 012-0057-00.

Purpose: Use in low-frequency signal-tracing setup to apply the oscilloscope calibrator signal to the Type 3A7 and to the test oscilloscope (item 3) Ext Trig input connector

6. BNC T Connector

Description: Fits on BNC jack and two BNC plugs. Tektronix Part No. 103-0030-00.

Purpose: Use in the low-frequency signal-tracing setup for connecting two BNC coaxial cables (item 5) to the oscilloscope Cal Out connector.

7. Miscellaneous: Replacement tubes, transistors and diodes.

Interconnecting-Plug Resistance Checks

Table 4-2 lists the approximate resistance measured between the interconnecting-plug pins and ground of the 24-pin plug located on the rear panel of the Type 3A7. The 1-to-2 measurement was made between pins 1 and 2 of the plug. These measurements were taken with the unit disconnected from the oscilloscope and the Vc RANGE switch set to 0.

The measurements are not absolute and may vary considerably since semiconductors in the circuitry cause different types of ohmmeters to have different readings. Significant differences between ohmmeter types are: (1) the amount of internal voltage they use, (2) the currents required to obtain full-scale deflection in each range, and (3) the meter scale readings. If ohmmeters were identical, the resistance measurements given in the table would be typical.

TABLE 4-2

Approximate Resistances of Interconnecting Plug¹

Pin No.	Type of Meter: VOM, Simpson Model 262			Type of Meter: Model: Type 3A7 Serial No.:		
	Resistance Readings		Ohms Range Used	Resistance Readings		Ohms Range Used
	+ Gnd ²	- Gnd ³		+ Gnd ²	- Gnd ³	
1	110 k	110 k	RX10K			
2	110 k	110 k	RX10K			
1-to-2 ⁴	0.8 Ω	0.8 Ω	RX1			
6	620 k	640 k	RX100K			
9	0 (Gnd)	0 (Gnd)	RX1			
10	620 k	640 k	RX100K			
11	22 k	11 k	RX1K			
15	4.7 k	4.8 k	RX1K			
16	3.2 Ω	3.2 Ω	RX1			
17	620 k	640 k	RX100K			
20	4.7 k	4.8 k	RX1K			
21	620 k	640 k	RX100K			
22	1k	1 k	RX100			
23	11.8 k	8.3 k	RX1K			
24	0 (Gnd)	0 (Gnd)	RX1			

¹Measured between interconnecting-plug pin and ground (chassis) with Vc RANGE switch set to 0. Pins not listed have no circuit connection (infinite resistance).

²Plus (+) polarity ohmmeter lead connected to chassis.

³Minus (-) polarity ohmmeter lead connected to chassis.

⁴Measured between pins 1 and 2.

Maintenance-Type 3A7

TABLE 4-3
Troubleshooting Chart

Symptoms	Checks to Make	
	Possible Causes	Area at Fault
1. No trace.	Check these supply voltages in the Type 3A7: +300, +300 decoupled, +250, +125, +81, +24, -12.2 and -100 volts, 6.3 Vac. If a voltage is incorrect, find trouble. Some possible causes are: Defective interconnecting plug. R310, R314, R318, R320 open. D324 defective. Open filament in a tube. If voltages are correct but trouble not found, go to third column.	Check for dc imbalance in Type 3A7 stages. Refer to topic - Isolating DC Imbalance.
2. Stationary trace; cannot be positioned.		Check Output Amplifier Q154-Q254-Q164-Q264-Q1 74-Q27-V174-V274 Stage.
3. Trace but no signal display when signal is applied to input A.	Defective AC-DC-GND switch SW101. Open connection at A input connector or at switch SW101.	Check input circuit of V13. Refer to Topic - Signal Tracing.
4. Trace but no signal display when signal is applied to input B.	Defective AC-DC-GND switch SW201. Open connection at B input connector or at switch SW201.	Check V213 input circuit. Refer to Topic - Signal Tracing.
5. Low or incorrect gain using either input.		Signal trace through the Type 3A. Refer to Topic-Signal Tracing.
6. Loss of or poor internal triggering.	Q284 defective. Q294 defective.	Troubleshoot Signal Trigger. Q284-Q294 Takeoff stage.
7. Up and down indicator lights work improperly stage.	Q304 defective.	Troubleshoot Position Indicators 0304
8. Comparison voltage incorrect when Vc RANGE switch is set to -11, -1.1, +1.1 or +11.	D301 defective.	Check for trouble in these circuits Vc Supply, Vc Range or Vc Output,

To allow for differences between ohmmeter types, blank columns are provided in the table for logging your own measurements. Space at the top of the columns is provided to record the type of meter used, model number and Type 3A7 serial number.

Troubleshooting Chart

Table 4-3 is a troubleshooting chart that lists some symptoms with possible causes and probable area at fault. The third column has some references to topics that describe in more detail how to troubleshoot the Type 3A7 when there is a dc-imbalance or improper-gain trouble.

Isolating DC Imbalance

To make the trace appear at the center of the crt, the dc output voltage at pins 17 and 21 of the interconnecting plug must be essentially equal. To make the trace appear within

the usable viewing area of the crt, the dc voltage measured between pins 17 and 21 must be less than ± 80 volts (based on a crt vertical deflection factor of 20 volts/div). A voltage difference which exceeds ± 80 volts between these two points may position the trace above or below the range of visibility. The up and down position indicator lights will show whether the trace is above or below the crt viewing area.

The dc voltages at pins 17 and 21 of the interconnecting plug depend on the dc balance of each stage. Since all the amplifier stages are dc coupled, any excessive imbalanced condition existing anywhere between input and output of the Type 3A7 can unbalance the output and cause the trace to be deflected out of the viewing area.

A procedure for isolating the cause of dc imbalance is as follows:

1. Set the Type 3A7 front-panel controls to these positions:

Maintenance-Type 3A7

Vc RANGE	As is
COMPARISON VOLTAGE	As is
AC-DC-GND (A and B)	GND
INPUT ATTEN	10
DISPLAY	A-B
MILLIVOLTS/CM	50
VARIABLE	CALIB
POSITION	Centered

2. Connect a dc voltmeter (starting from the input) between corresponding points in the amplifier as shown in Fig. 4-5 to determine the area where the imbalance originates. For example, if the voltmeter is connected between the cathodes of V113 and V213 and the reading is within the range indicated in the illustration, then this stage is properly dc balanced. It also means that the DIFF BAL, DC BAL and HEATER BAL controls are properly adjusted. If the voltmeter is connected between the plate of V124B and the plate of V224B and if the reading is greater than

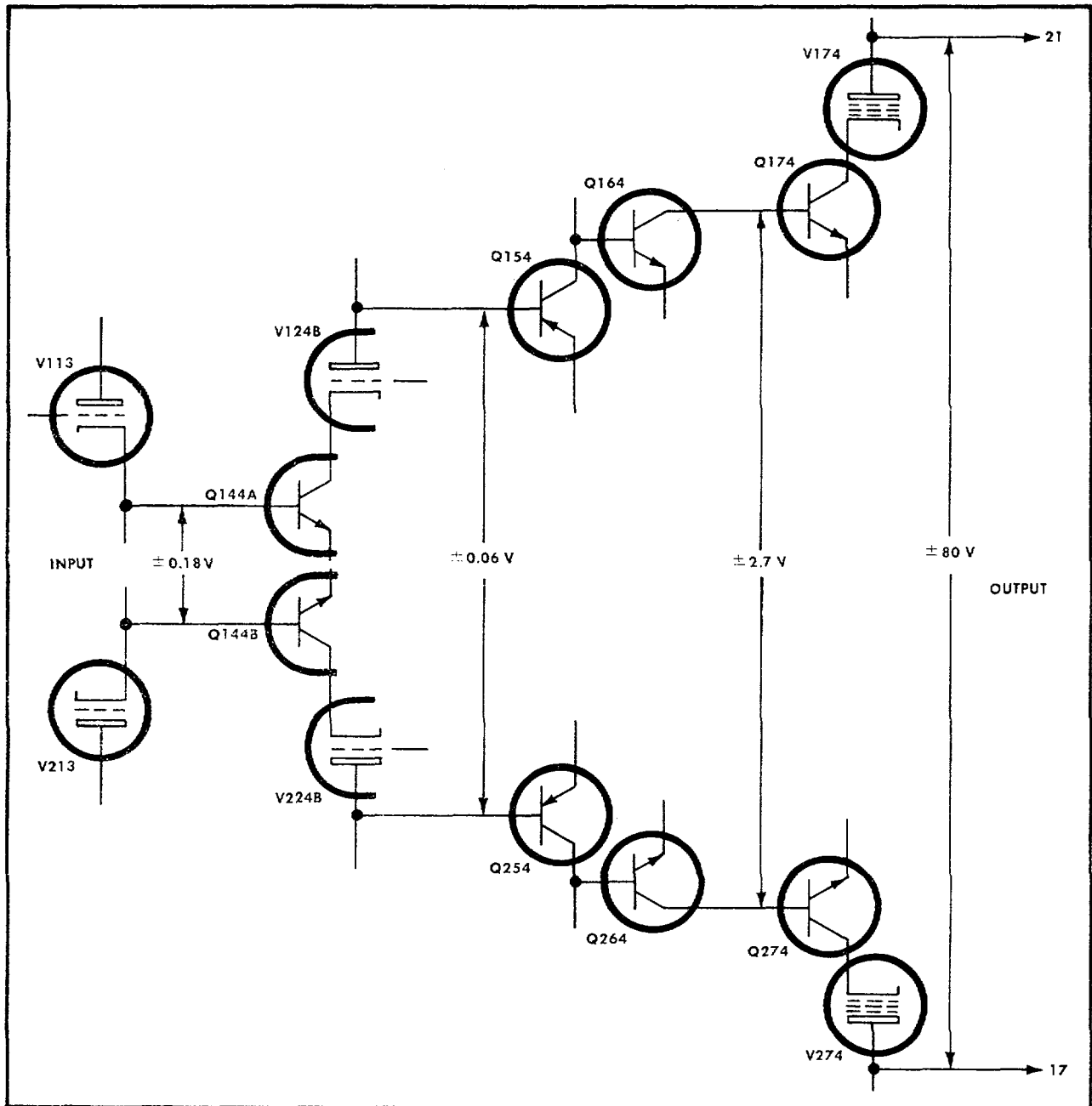

Fig. 4-5. Simplified schematic diagram showing dc balance voltage limits at various points which, if not exceeded, should position the trace on the crt.

Maintenance-Type 3A7

the voltage range given in the illustration, then the dc imbalance originates in the Comparator stage V124B-V224B-Q144A-Q144B-Q234.

3. To determine the exact cause of dc imbalance in a stage, detailed checks must be made such as: check the semiconductors in the stage, check voltages and resistances. When defective components are found and replaced, check the calibration of that portion of the circuitry.

Signal Tracing

A method is described here for checking waveform amplitude, polarity and dc level at the points shown on the Differential Amplifier diagram. The technique used here is limited to the low frequencies because a flexible-cable extension is used to operate the Type 3A7 out of the oscilloscope plug-in compartment. The cable extension permits access to all sides of the Type 3A7 for detailed signal tracing and troubleshooting.

After the troubles in the Type 3A7 are found and corrected at the low frequencies, then it is easy to go directly to the Calibration procedure in Section 5 to check high-frequency transient response and other performance requirements.

IMPORTANT

The amplitude and dc level of each waveform shown after the input stage on the schematic are not absolute, but can be used as a signal-tracing guide. Waveforms may vary due to stage gain, crt deflection plate sensitivity, normal manufacturing tolerances and characteristics of tubes and semiconductors.

To signal trace the Type 3A7 stages, proceed as follows:

1. Set the front-panel controls of the Type 3A7 to the same positions as listed in the Important note located on the inside section of the Differential Amplifier schematic fold-out page.

2. Connect a 30-inch plug-in cable extension between the Type 3A7 and the associated oscilloscope.

3. Apply a 2-volt peak-to-peak calibrator signal through coaxial cables to the Type 3A7 input A connector and to the

test oscilloscope (item 3 in Test Equipment list) Ext Trig input connector.

4. Set the test oscilloscope input coupling switch to AC and set the triggering controls for +Ext triggering on the 2-volt calibrator signal.

5. Touch the test-oscilloscope probe tip to the rear side of the Type 3A7 input A AC-DC-GND switch where the signal comes in. Set the test oscilloscope front-panel controls to display one or two cycles of the calibrator waveform. Be sure to set the test oscilloscope triggering controls so the first 1/2-cycle of the waveform is positive going. The displayed waveform on the test oscilloscope should correspond to the input waveform polarity shown at the A input connector on the schematic diagram. Disconnect the probe.

6. Touch the probe tip to the desired test point in the Type 3A7 circuitry. Select a test point where a waveform is shown on the schematic. Set the test oscilloscope vertical deflection factor to correspond to the setting given at the left side of the waveform shown on the schematic.

7. Check polarity and amplitude of the waveform. Then disconnect the probe.

8. To check the instantaneous dc level of the waveform at the test point used in steps 6 and 7, set the test oscilloscope input coupling switch to DC. Preset the test oscilloscope vertical deflection factor such that the expected dc voltage to be measured in step 9 will keep the display within the graticule viewing area. The expected voltage is indicated at the right side of the waveform on the schematic. Ground the probe tip to the Type 3A7 chassis and position the trace to establish a zero reference point.

9. Touch the probe tip to the same test point used in step 6 of this procedure. Determine the dc level of the waveform by measuring the voltage between the reference point established in step 8 and the dc-level point indicated at the right side of the waveform shown on the schematic. Disconnect the probe.

10. Continue on to the next test point and repeat steps 6 through 9 until you reach a test point where an abnormal indication is definitely obtained. Then proceed with detailed troubleshooting checks in that stage to find the cause of the trouble. Such checks usually consist of signal-tracing between test points to check where the signal stops, semiconductor or tube substitution, voltage and resistance checks.

SECTION 5

MAINTENANCE CALIBRATION 1

Introduction

The Type 3A7 should be calibrated every 500 hours or every six months if used intermittently. If transistors, tubes or other components are replaced, the calibration of the repaired circuit should be checked.

The following procedure is arranged in a sequence which will allow the unit to be calibrated with the least interaction of adjustments and reconnection of equipment. If desired, the steps may be performed out of sequence or a step may be performed individually, providing interaction between adjustments is considered. It may be necessary to refer to the preceding step(s) and/or Preliminary Procedure for additional setup information. When referring to preceding step(s), a list of the front-panel control settings is provided at major points in the procedure so a start can be made at any of those points.

NOTE

This procedure contains performance checks of the unit along with a complete calibration. Steps entitled 'Check' are the performance checks. All other steps are entitled 'Adjust'. The symbol  is included in the 'adjust' title so these steps can be located easily.

As an additional aid, a calibration record is provided at the beginning of this section. It lists all the 'check' and 'adjust' steps. Boxes are provided so each step can be checked off as it is completed. A brief explanation below each step is included so an experienced calibrator can use the check-off list as a condensed procedure.

NOTE

If desired, make a copy of the Calibration Record prior to calibrating the unit. Use the copy during the procedure. When completed, it can be used as a record of the calibration.

EQUIPMENT REQUIRED

The following equipment, or equivalent, is required for a complete calibration of the Type 3A7. Exception: Item 7 dc voltmeter can be deleted if you use item 8 to perform steps 2 and 6 in the procedure. Fig. 5-1 shows items 1 through 8; Fig. 5-2 shows items 9 through 23; Fig. 5-3 shows the adjustment tools needed.

(1) Oscilloscope, Tektronix 560-Series which accepts the Type 3A7 plug-in. The oscilloscope must operate properly.

(2) Type 267 Time-Base Plug-In Unit, or equivalent. Required if item 1 does not have its own internal time base.

It is recommended that the time base have an external horizontal input connector. This connector is used when

performing steps 18, 21 and 24 in the procedure. The X-Y display thus produced makes adjustment easier.

Horizontal deflection required is approximately 5 V/div. The Type 3B4 Time-Base Plug-in Unit (not shown in Fig. 5-1) is ideally suited for this purpose. Or, a plug-in amplifier can be used if the time-base unit does not have the external horizontal input facility.

If a Type 2B67 is used, the external input sensitivity is about 1 V/div. To obtain a deflection factor of about 5 V/div, simply connect a 50,000-ohm potentiometer between the Ext Input connector and ground as shown in Fig. 5-1, item 2.

If you prefer not to use an X-Y display to make the adjustments. The required CMRR can be obtained by adjusting the controls to obtain a minimum amplitude display.

(3) Standard Amplitude Calibrator (optional).

Description: Output frequency of about 1 kHz; peak-to-peak output amplitudes in 1-2-5 steps required for this procedure-5 mV to 200 mV; amplitude accuracy of $\pm 0.25\%$ or better at constant ambient temperature. Tektronix Part No. 067-0502-00.

Purpose: For use in performing steps 13, 14, 15, 32 and 33 of the calibration procedure, if greater accuracy than that provided by the oscilloscope calibrator is needed.

(4) Square-Wave Generator, Tektronix Type 105.

Required characteristics: Output frequencies of 1, 10 and 100 kHz. Output amplitude variable from 10 to 100 volts across its internal 600-ohm load. 13-nsec or less risetime into a 50-ohm cable terminated at both ends.

(5) Sine-wave generator. Tektronix Type 190B Constant-Amplitude Signal Generator.

Required characteristics: Output frequencies of 50 kHz (reference), 4, 6, 8, and 10 MHz; output amplitude must be adjustable (manually or automatically) for a constant amplitude at the stated frequencies; output amplitude range adjustable from 80 mV to 10 volts peak to peak.

(6) Sine-wave audio generator. Heathkit Model AG-10 or IG-82.

Required characteristics: Output frequencies of 20, 60 and 200 Hz; 2, 20 and 500 kHz. Output amplitude 30 volts peak to peak (15 volts peak referenced to ground).

(7) Dc voltmeter (VOM). Sensitivity of 20,000 Ω/V at full deflection.

(8) Precision dc voltmeter. Nulling type with infinite impedance at null.

Required characteristics: Accuracy of 0.05% or better; resolution of 50 μ volts or better. If a John Fluke Differential Voltmeter is available, use Model 801B or equivalent. If an accuracy of $\pm 0.01\%$ is desired use a Model 821A.

(9) Precision Dc Divider. 10X and 100X attenuation; Tektronix Part No. 067-0503-00.

1. This procedure is for use after repair. For calibration procedure, see TB 750-236.

Calibration-Type 3A7

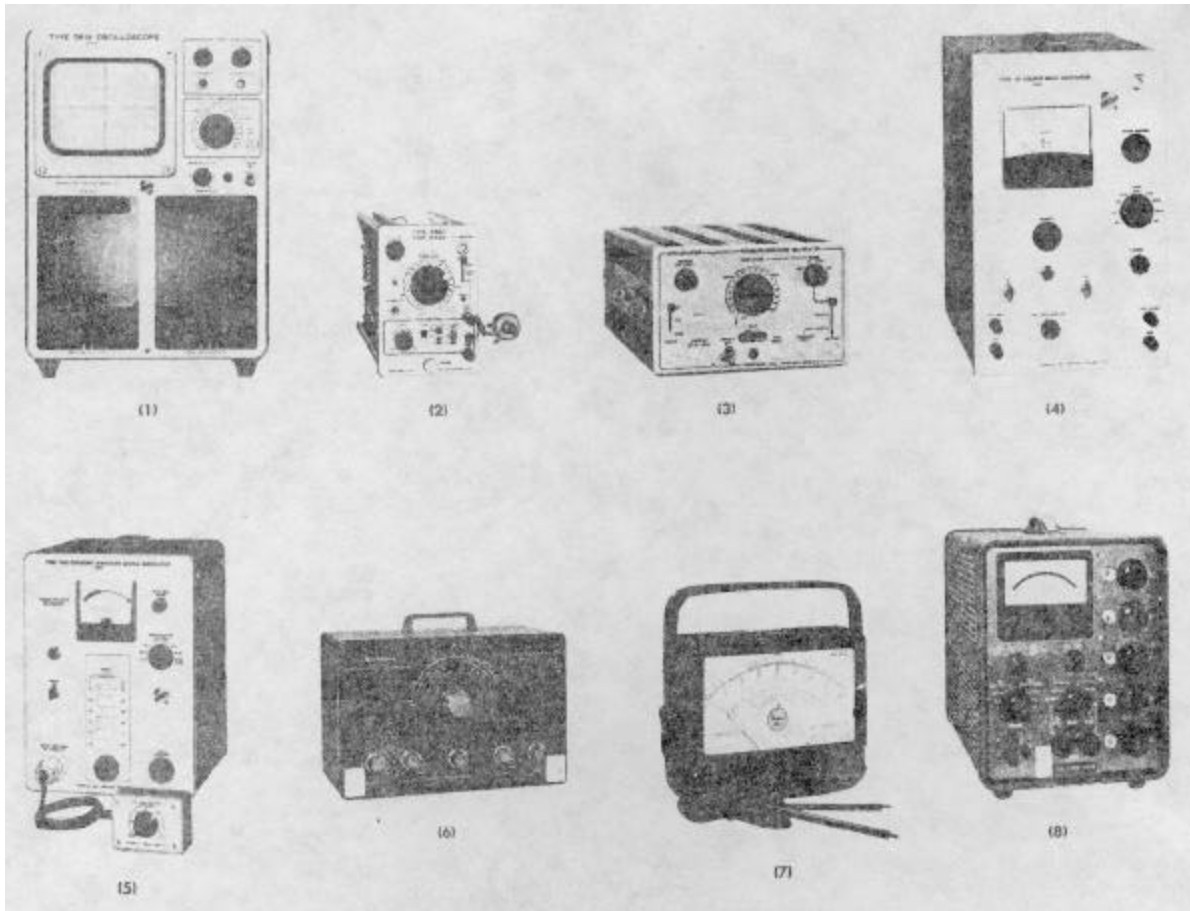

Fig. 5-1. Equipment required for a complete calibration of the Type 3A7.

(10) Type TU-5 Pulser package, Tektronix Part No. 015-0043-00, contains the following items¹:

Qty.	Description	Tektronix Part No.
1	Type TU-S Pulser (alone) with BNC plug and jack connector fittings.	015-0038-00
1	50-ohm 10X attenuator with BNC plug and jack connector fittings.	011-0059-00
1	50-ohm termination with BNC plug and jack connector fittings.	011-0049-00
1	Connector adopter with UHF plug and BNC jack connector fittings.	103-0015-00
1	50-ohm (nominal impedance) coaxial cable, 42 inches long, with a BNC connector on each end.	012-0057-00

¹If desired, any of the foregoing items can be ordered separately through your local Tektronix Field Engineer or Field Office. When ordering, give complete description and part number.

TU-5 Pulser (015-0038-00) characteristics:

Input Drive Signal --+100-volt (from ground) square wave capable of supplying 10 mA. To use the Type 105 Square-Wave Generator as the driving source for the TU-5 Pulse, an adopter (item 11) must be used to convert the -100-volt (from ground) square wave from the Type 105 into a +100-volt signal. Use of the Type 105 provides a bright display due to its higher repetition rate capabilities.

Output Amplitude-At least 200 mV with output terminated into 50 ohms.

Output Pulse Risettime-Less than or equal to 0.3 nsec into 50 ohms.

(11) TU-5/105 Adopter, Tektronix Part No. 013-0075-00.

Purpose: Adapts the Type 105 for use as the driving source for the TU-5 Pulser

(12) Input time-constant standardizer.

Description RC = 1 MΩ X 20 pF; 2X voltage attenuation; equipped with one BNC plug and one BNC jack connector fittings. Tektronix Part No. 011-0066-00.

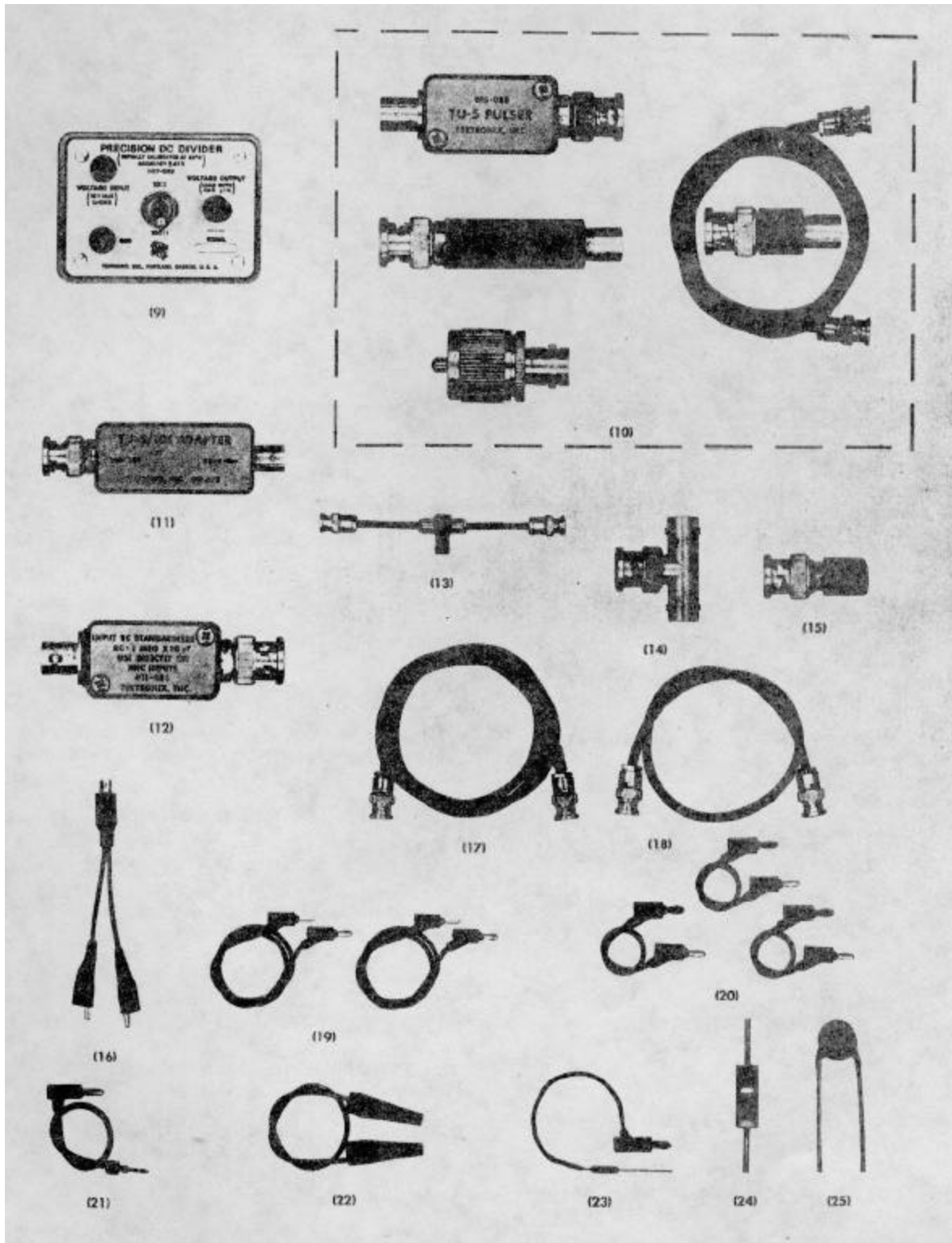

Fig. 5-2. Accessories used in calibration of the Type 3A7.

Calibration-Type 3A7

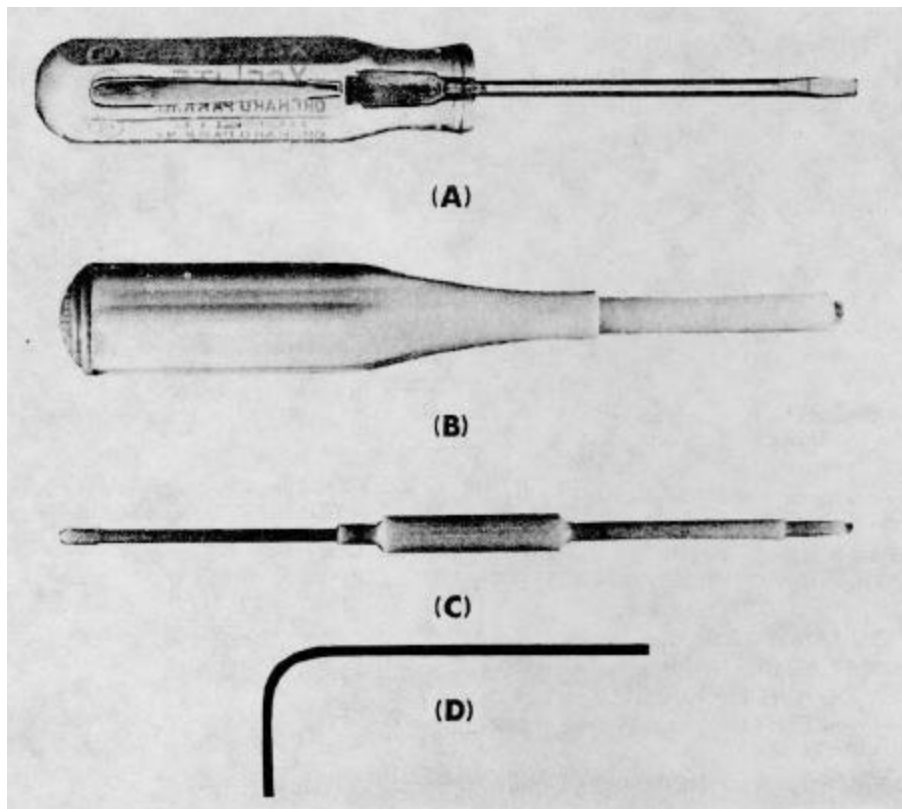

Fig. 5-3. Adjustment tools

(13) Dual-input BNC connector. Provides matched signal paths to both Type 3A7 input connectors. Tektronix Part No. D67-0525-00.

(14) BNC T connector. Fits a BNC jack and accepts two BNC plugs. Tektronix Part No. 103-0030-00.

(15) Two connector adapters. Single binding post fitted with a BNC jack connector fitting. Binding post accepts a banana plug. Tektronix Part No. 103-0033-00.

(16) Adapter, clip lead. Equipped with a BNC jack connector on one end and alligator clips on the leads. Tektronix Part No. 013-0076-00.

(17) 50-ohm (nominal impedance) coaxial cable, 42 inches long, with a BNC plug connector on each end. Tektronix Part No. 012-0057-00.

(18) 50-ohm (nominal impedance) coaxial cable, 18 inches long; equipped with a BNC plug connector on each end. Tektronix Part No. 012-0076-00.

(19) Two patch cords, 18 inches long, with banana plug and jack combination connector on each end. Tektronix Part No. 012-0031-00.

(20) Three patch cords, 6 inches long, with banana plug and jack combination connector on each end. Tektronix Part No. 012-0024-00.

(21) Jumper lead, 6 inches long, with a tip plug on one end and a banana plug and jack combination connector on the other end. (Tip plug fits Vc OUT jack on Type 3A7.)

(22) Jumper lead, 7 inches long, with miniature insulated alligator clips on each end.

(23) Resistor, fixed, 1 M Ω , 1/2 or 1/4 W, 1%. Tektronix Part No. 323-0481-00 for the 1/2-W resistor. Solder a 4-inch lead equipped with a banana plug to one lead of the resistor.

(24) Resistor, fixed, 47 Ω , 1/2 W, 10%. Tektronix Part No. 302-0470-00.

(25) Capacitor, fixed, 0.001 μ F, 50V or higher. Tektronix Part No. 283-0000-00 for a 500-V discap capacitor.

(26) Adjustment tools (one each, see Fig. 5-3):

a. Small screwdriver with a 1/8-inch wide tip to fit the small screwdriver-adjust potentiometers.

b. Insulated low-capacitance screwdriver, Jaco No. 125, 1 1/2-inch shank, 1/8-inch wide metal tip. Tektronix Part No. 003-0000-00.

Calibration-Type 3A7

c. Hexagonal wrench, 0.1 inch double-ended, Walsco No. 2543. Tektronix Part No. 003-0301-00.

d. Hexagonal wrench, 0.050 inch. Fits COMPARISON VOLTAGE 10-turn dial setscrew. (Not needed if dial reads exactly zero in the fully counterclockwise position.)

CALIBRATION RECORD

Tektronix Type 3A7

Serial No. _____

- 1. Adjust FIL BAL R338. (Page 5-7).
Trace positioned at or near graticule center (within ± 1 div) at 1 mV/div.
- 2. Adjust DRIVER DC LEVEL R260. (Page 5-8).
+59 volts between TP264 and ground.
- 3. Adjust DC BAL (R130). (Page 5-8).
Minimum trace shift at 5mV/div when VARIABLE control is rotated back and forth.
- 4. Adjust AMP BAL (R233). (Page 5-9).
Minimum trace shift as MILLIVOLTS/DIV switch is set from 50 to 1.
- 5. Adjust POSITION RANGE R253. (Page 5-9).
Trace positioned to graticule center.
- 6. Adjust SIG/TRIG DC LEVEL R288. (Page 5-9).
Zero volts between TP294 and ground with trace positioned to graticule center.
- 7. Check Vertical Position Indicator Lights. (Page 5-10).
Up neon turns on as trace is positioned to top of graticule and down neon turns on as trace is positioned to bottom of graticule.
- 8. Check COMPARISON VOLTAGE 10-Turn Dial for Mechanical Zero reading. (Page 5-10).
Fully counterclockwise dial indication should be 0 volts (0-0).
- 9. Adjust Vc CAL R410. (Page 5-11).
+ 11 volts between Vc OUT jack and ground when Vc RANGE switch is set to +11 and COMPARISON VOLTAGE control set to 11 v (10-10-0).
- 10. Adjust TRACKING R423. (Page 5-11).
+1 volt between Vc OUT jack and ground when COMPARISON VOLTAGE control is set to 1.00 (0-10.0).
- 11. Check Vc Divider (COMPARISON VOLTAGE switch). (Page 5-11).
First digit voltages checked for accuracy according to Table 5-1 in Calibration Procedure.
- 12. Check COMPARISON VOLTAGE 10-Turn Potentiometer Linearity. (Page 5-12).
Check second digit voltages for accuracy according to Table 5-2 in Calibration Procedure.
- 13. Adjust AMP CAL (R244). (Page 5-12).
5-div display with 5mV input deflection factor of 1 mV/div.
- 14. Check VARIABLE (MILLIVOLTS/DIV) Control. (Page 5-13).
Deflection factor ratio of 2.5: 1 or more.
- 15. Check MILLIVOLTS/DIV Switch. (Page 5-13).
Vertical deflection factor of $\pm 3\%$ of indicated value.
- 16. Check Input CF Grid Current. (Page 5-14).
1 nanoampere or less.
- 17. Check for Microphonics. (Page 5-14).
1 mV or less.
- 18. Adjust DIFF BAL R216 and CF LOAD BAL R212. (Page 5-14).
Minimum common-mode difference display amplitude.
- 19. Adjust C120 (Input A Overdrive Fast Recovery). (Page 5-18).
Within 10 mV of final signal value in 300 ns.
- 20. Check Input A Overdrive Dc Shift. (Page 5-19).
5 mV or less after 1 s.
- 21. Adjust C113 C213 and C220 (Common-Mode Rejection at 20 kHz). (Page 5-20).
1.5 mV or less display amplitude.
- 22. Check Input B Overdrive Fast Recovery. (Page 5-21).
Within 10 mV of final signal value in 300 ns.
- 23. Check Input B Overdrive Dc Shift. (Page 5-22).
5 mV or less after 1 s.
- 24. Check Sine-Wave Common-Mode Rejection Requirements. (Page 5-22).
Fulfills rejection requirements as listed in Table 5-4 of the Calibration Procedure.
- 25. Check DC Common-Mode Rejection. (Page 5-23).
0.5 div or less trace shift from reference.
- 26. Adjust R106E (Input A 10X Attenuator). (Page 5-24).
For null indication between the precision 10:1 divider and 10X attenuator.
- 27. Adjust R108G (Input A 100X Attenuator). (Page 5-26).
For null indication between the precision 100:1 divider and 100X attenuator.
- 28. Adjust R105B (Input A 1X Attenuator). (Page 5-27).
Voltage across 1X 1-M Ω resistor matches voltage across 10X attenuator.
- 29. Adjust R206E (Input B 10X Attenuator). (Page 5-27).
For null indication between the precision 10:1 divider and 10X Attenuator.
- 30. Adjust R208G (Input B 100X Attenuator). (Page 5-28).
For null indication between the precision 100:1 divider and 100X attenuator.
- 31. Adjust R205B (Input B 1X Attenuator). (Page 5-28).
Voltage across 1X 1-M Ω resistor matches voltage across 10X attenuator.
- 32. Check Input B 1000X Attenuator. (Page 5-28).
5-div display, $\pm 3\%$, with 5 volts input; deflection factor of 1 mV/div.
- 33. Check Input A 1000X Attenuator. (Page 5-29).
5-div display, $\pm 3\%$, with 5 volts input, deflection factor of 1 mV/div.
- 34. Adjust Input Attenuator Compensation. (Page 5-30).
Optimum square-wave response for both inputs.
- 35. Adjust C255, C281, R280, L170 and L270 (High-Frequency Transient Response). (Page 5-33).
Optimum square-wave transient response for both inputs. Aberrations no greater than 2.5% of display amplitude.

Calibration-Type 3A7

- ❑ 36. Check High-Frequency Sine-Wave Response. (Page 5-36).
Upper end 30% down point frequency response checked for all MILLIVOLTS/DIV switch settings per Table 5-6 in the Calibration Procedure. Both inputs checked.
- ❑ 37. Check Input Crosstalk. (Page 5-37).
Less than 5% feed-through to other input. Both inputs checked.

Calibration Engineer _____

Date _____

PRELIMINARY PROCEDURE

- (1) Insert the time base into the oscilloscope compartment for horizontal deflection of the beam.
- (2) Remove the oscilloscope panels which allow access to the Type 3A7 internal adjustments.

(3) Connect the power cord from the oscilloscope to the proper operating voltage for which the oscilloscope is wired.

(4) Turn on the oscilloscope and allow about 15 minutes for warm up and complete stabilization.

(5) Preset the Type 3A7 front-panel controls as follow:

Vc RANGE	0
COMPARISON VOLTAGE	0 (0-0-0 ¹)
AC-DC-GND (A and B)	GND
INPUT ATTEN	1
DISPLAY	A-B
MILLIVOLTS/DIV	50
VARIABLE	CAL
POSITION	Centered

(6) Set the oscilloscope sweep rate and triggering controls to obtain a 0.5 m/div free-running sweep. Fig. 5-4 shows the setup up to this point in the procedure.

¹Method used throughout the manual to describe consecutive reading order of digits. For more information refer to Section 2, Fig. 2-1.

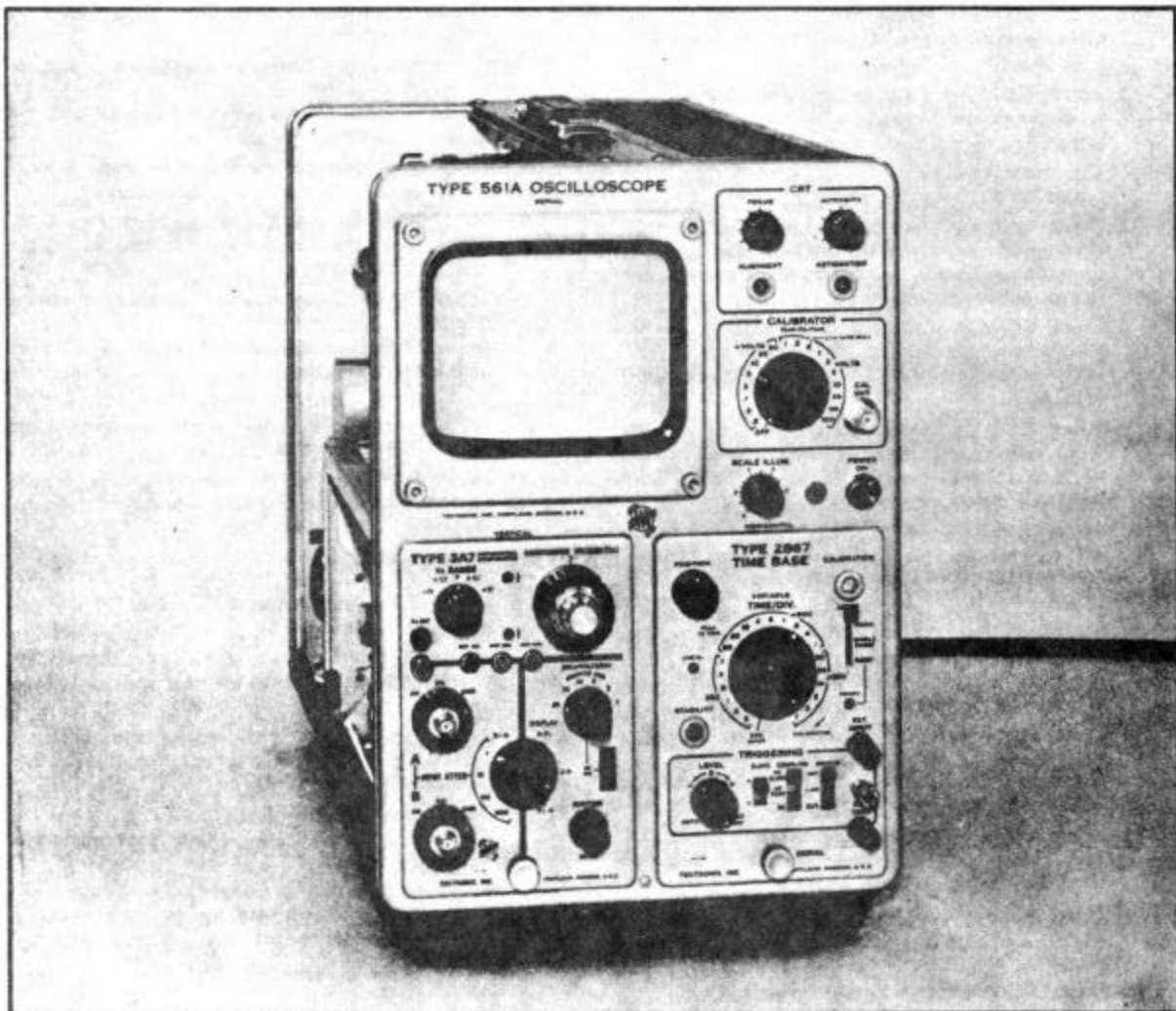

Fig. 5-4. Setup at completion of preliminary procedure.

CALIBRATION PROCEDURE

1. Adjust FIL BAL R338

- a. Preset the front-panel AMP BAL and DC BAL adjustments (see Fig. 5-5a) to midrange.
- b. Preset the POS RANGE control R253 (see Fig. 5-5b) to midrange.
- c. Slowly adjust the FIL BAL control R338 (see Fig. 5-5b) so the trace coincides with graticule center.

NOTE

The FIL BAL adjustment changes the heater voltage on the Input CF tubes V113 and V213. Therefore, when making the adjustment, allow time for the trace to stabilize as the heaters and cathodes reach their operating temperature.

- d. Set the MILLIVOLTS/DIV switch to progressively lower deflection factors while repeating step c. The FIL BAL control is properly adjusted if the trace is at or near (within ± 1 div) graticule center when the MILLIVOLTS/DIV switch is set to 1.

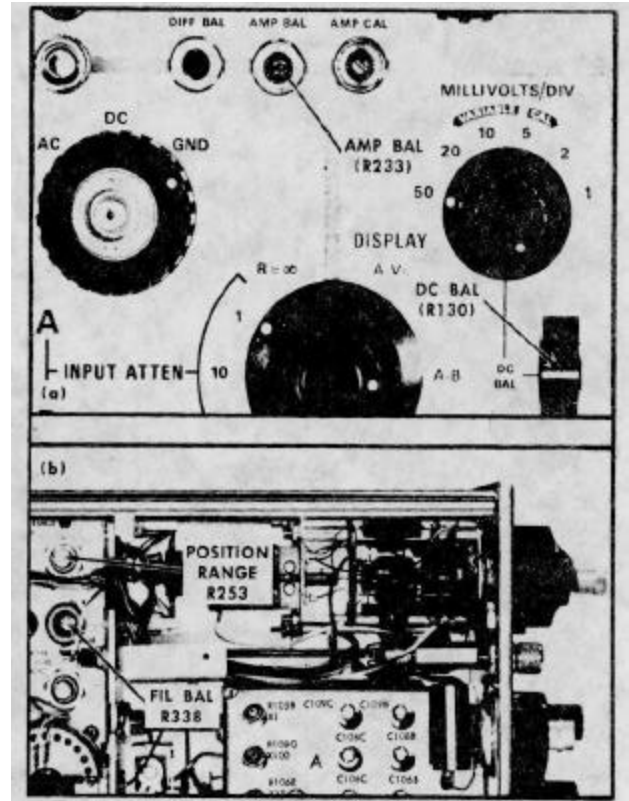

Fig. 5-5. (a) and (b) show location of step 1 adjustments.

Calibration-Type 3A7

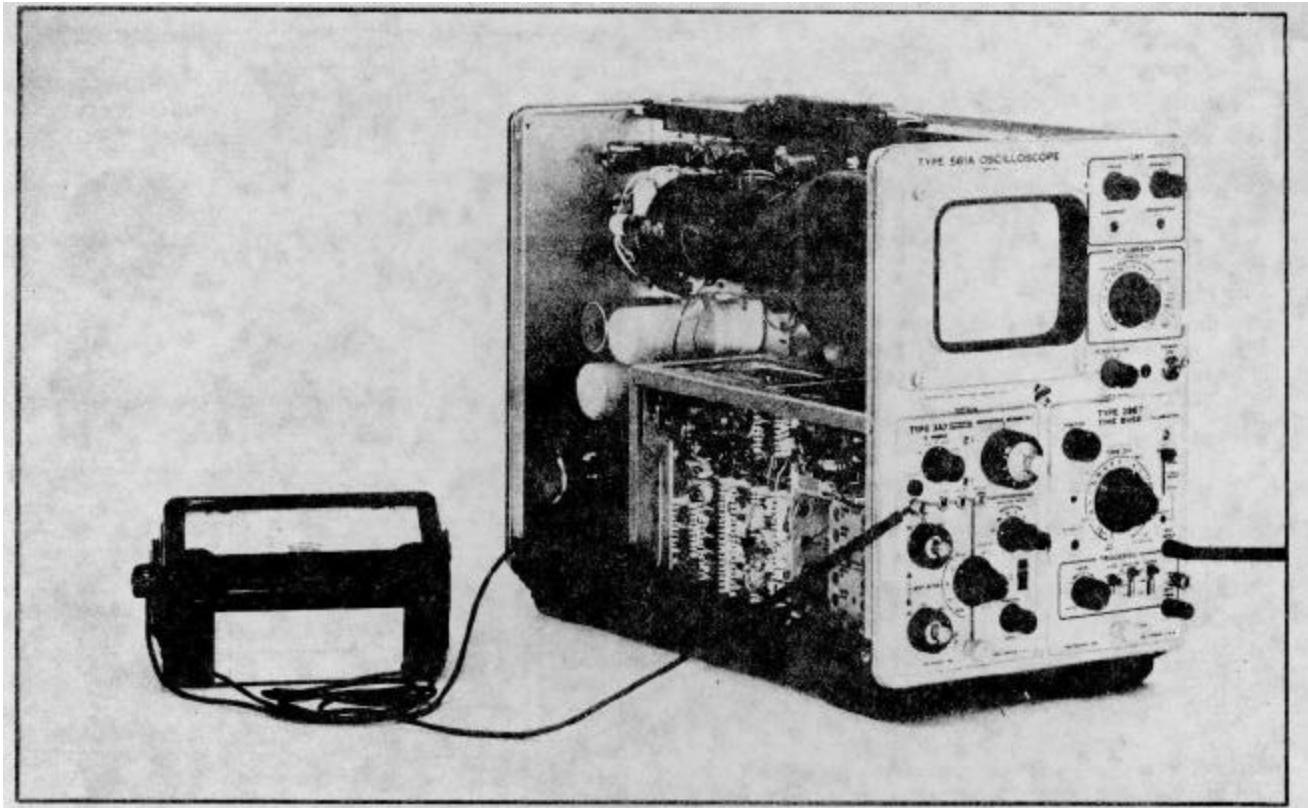

Fig. 5-6. Setup at completion of step 2a.

2. Adjust DRIVER DC LEVEL R260 ❶

a. Connect a dc voltmeter between TP264 and ground. Fig. 5-6 shows the complete setup and Fig. 5-7 shows the test point location.

b. Adjust the DRIVER DC LEVEL control R260 (see Fig. 5-7) to obtain a reading of exactly +59 volts on the voltmeter.

c. Disconnect the voltmeter.

c. Set the MILLIVOLTS/DIV switch to 1 and repeat step 3b.

d. Set the VARIABLE control to its CAL position

3. Adjust DC BAL R130 ❷

a. Set the MILLIVOLTS/DIV switch to 5.

b. Adjust the DC BAL control (see Fig 5-8) so there is minimum trace shift as the VARIABLE (MILLIVOLTS/DIV) control is rotated back and forth.

NOTE

Use the front-panel AMP BAL R233 control as a positioning control to keep the trace near graticule center.

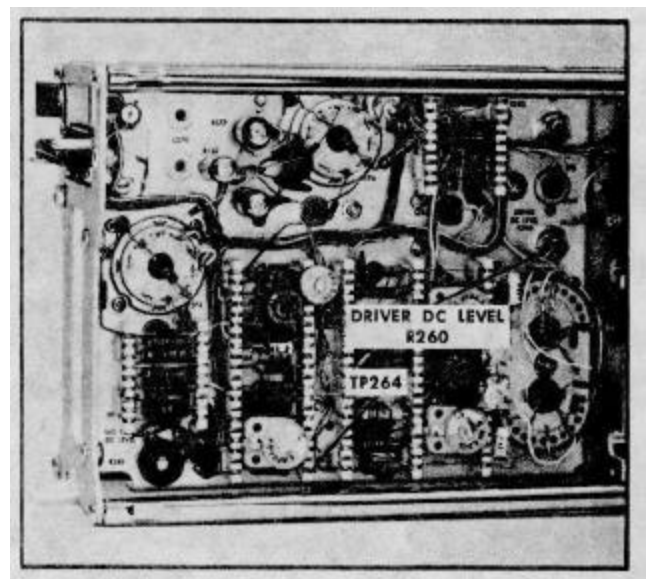

Fig. 5-7. Step 2 test point and adjustment locations.

4. Adjust AMP BAL R233 ①

- a. Set the MILLIVOLTS/DIV switch to 50 and note the position of the trace.
- b. Set the MILLIVOLTS/DIV switch to 1.
- c. Adjust the AMP BAL control R233 (see Fig. 5-8) so the position of the trace matches the position noted in step 4a. To check on the accuracy of the adjustment, set the MILLIVOLTS/DIV switch to its various positions. There should be no trace shift.
- d. Due to interaction between the DC BAL and AMP BAL controls, repeat steps 3b through 4c to obtain minimum trace shift as the VARIABLE and MILLIVOLTS/DIV controls are rotated back and forth.

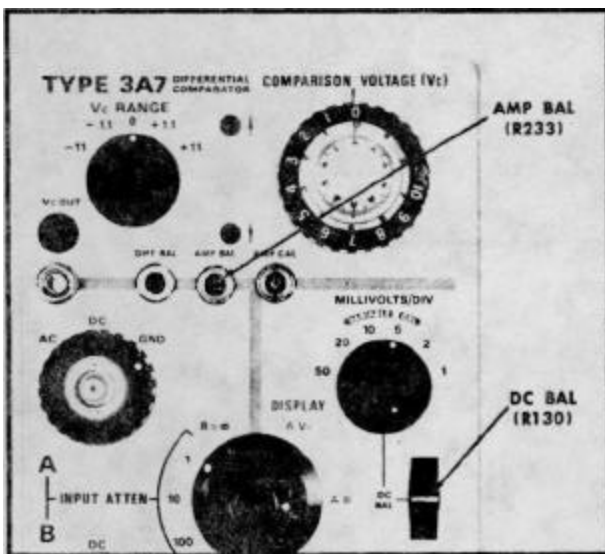

Fig. 5-8. Steps 3 and 4 adjustment locations.

NOTE

From time to time throughout the remaining portion of the procedure, it may be necessary to readjust the DC BAL control to obtain minimum trace shift as the MILLIVOLTS/DIV or VARIABLE controls are rotated.

5. Adjust POSITION RANGE R253 ①

- a. Check that the VARIABLE control is set to CAL and the MILLIVOLTS/DIV switch is set to 1.
- b. Adjust the POSITION RANGE control R253 (see Fig. 5-9) so the trace coincides with graticule center.

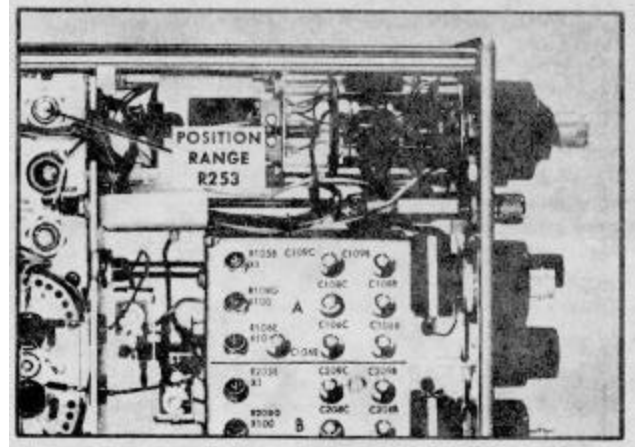

Fig. 5-9. Step 5 adjustment location.

6. Adjust SIG/TRIG DC LEVEL R288 ①

- a. Connect a dc voltmeter between TP294 (see Fig. 5-10) and ground. The setup is similar to that shown in Fig. 5-6.
- b. Adjust the SIG/TRIG DC LEVEL control R288 (see Fig. 5-10) to obtain a zero reading on the voltmeter. Due to slight dc drift, exact zero is difficult to obtain. So allow a tolerance of about ± 0.1 volt. Be sure the trace coincides with graticule center when adjusting the control. Use the POSITION control to keep the trace centered.
- c. Disconnect the voltmeter.

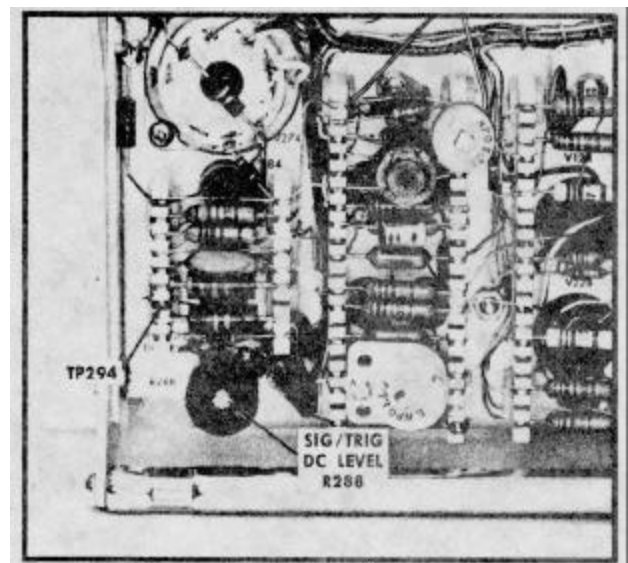

Fig. 5-10. Step 6 test point and adjustment locations.

Calibration-Type 3A7

7. Check Vertical Position Indicator Lights

a. Check that the up ↑ neon turns on as the trace is positioned toward the top of the graticule using the Type 3A7 POSITION control. The down ↓ neon should be turned off.

b. Use the POSITION control to move the trace downward. When the trace is at or near center, both neons will extinguish. Typically, both neons remain extinguished in a narrow positioning range of about 1 minor division. As the trace is positioned to the bottom of the graticule, the up neon should remain extinguished and the down neon should be turned on.

8. Check COMPARISON VOLTAGE 10-Turn Dial for Mechanical Zero Reading.

a. At this point in the procedure, the front-panel controls should be at the following positions:

Type 3A7

V_c RANGE 0
 COMPARISON VOLTAGE 0 (0-0-0)
 AC-DC-GND (A and B) GND

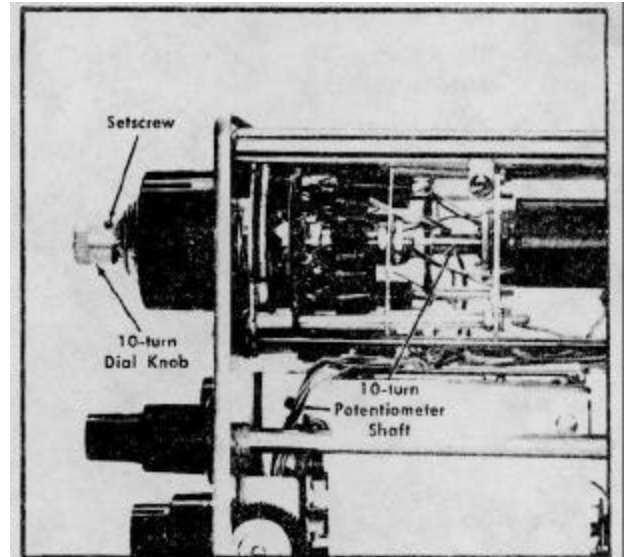

Fig. 5-11. Zero volts mechanical calibration, step 8.

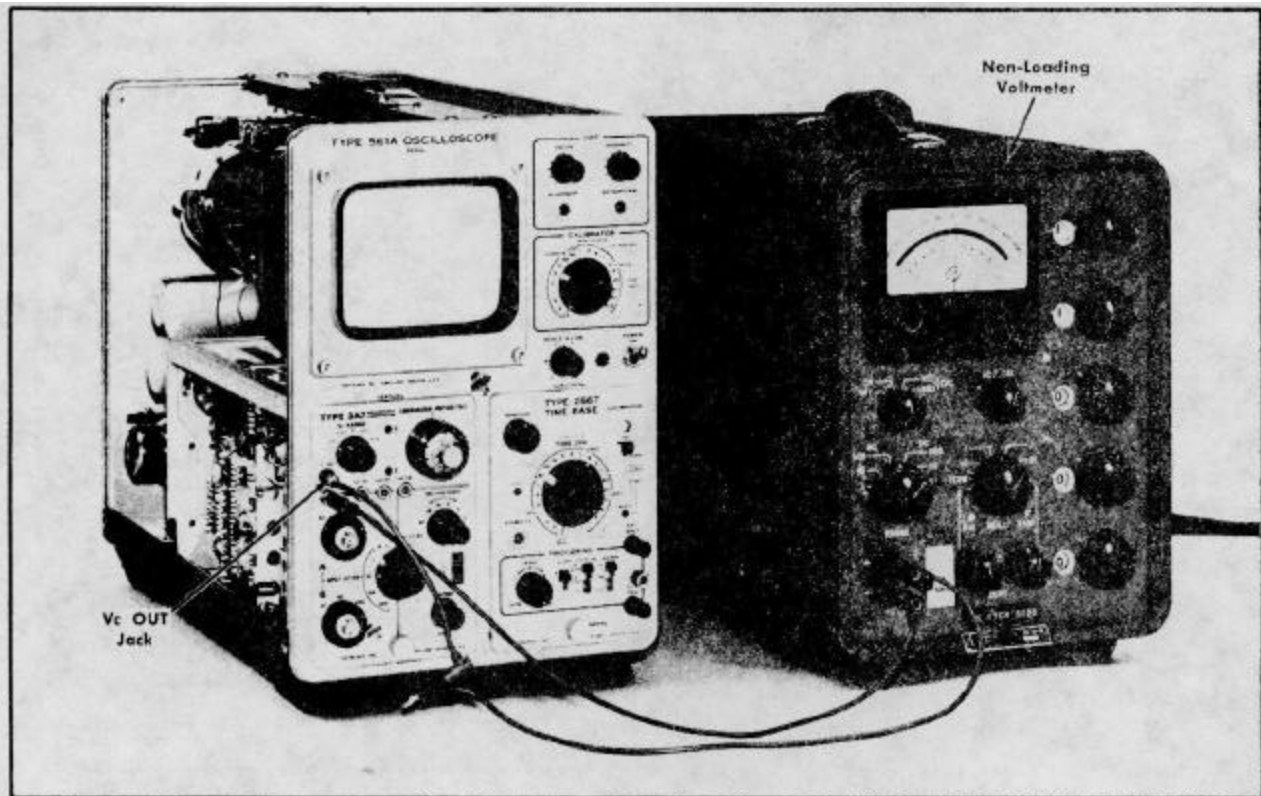

Fig. 5-12. Setup at completion of step 9c.

INPUT ATTEN 1
 DISPLAY A-B
 MILLIVOLTS/DIV 1
 VARIABLE CAL
 POSITION Set so trace is centered

Time Base

Position Set so trace starts at left side of graticule
 Time/Div .5 mSec
 Variable Calibrated
 Pull 5X Mag In
 Mode Norm
 Level Free Run
 Slope +
 Coupling AC Slow
 Source Int

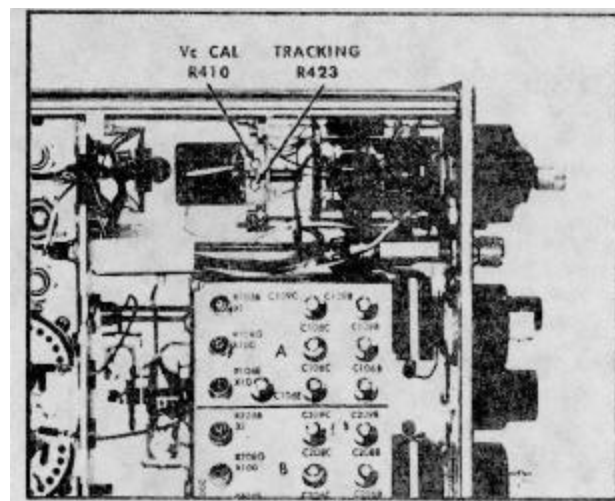

Fig. 5-13. Location of adjustments for step 9 and 10.

b. With the COMPARISON VOLTAGE 10-turn dial set at its most counterclockwise position, check that the 10-turn dial reads 0-0. If it does not, loosen the setscrew (see Fig. 5-11) in the 10-turn dial knob and set the dial for the proper zero reading without turning the potentiometer shaft.

c. Tighten the setscrew and repeat step 8b to be sure the dial is set correctly.

9. Adjust Vc CAL R410 ❶

a. Set the Vc RANGE switch to +11 and the COMPARISON VOLTAGE control to 11V (10-10-0).

b. Set the non-loading voltmeter (item 8) to +11 volts.

c. Connect the voltmeter between the Vc OUT jack and ground. Fig. 5-12 shows the setup.

d. Adjust the Vc CAL control R410 (see Fig. 5-13) for a null reading on the meter.

e. Disconnect the voltmeter.

10. Adjust TRACKING R423 ❷

a. Set the COMPARISON VOLTAGE control to 1.00 (0-10-0).

b. Set the non-loading voltmeter to +1 volt.

c. Reconnect the voltmeter between the Vc OUT jack and ground. (This setup is similar to the one shown in Fig. 5-12.)

d. Adjust the TRACKING control R423 (see Fig. 5-13) for a null reading on the meter.

11. Check Vc Divider (COMPARISON VOLTAGE Switch)

Using the same connections as described in step 10c, use the non-loading voltmeter to check the Vc divider voltages. For example, set the voltmeter to +2 volts and check for a null reading when the COMPARISON VOLTAGE control outer knob is set to 1 (1-10-0). Use Table 5-1 as a guide.

TABLE 5-1

COMPARISON VOLTAGE ¹ Outer Knob Setting	Voltage Reading	Maximum Deviation from Null ²
1	+2 Volts	8.5 mV
2	+3 Volts	10.0 mV
3	+4 Volts	11.5 mV
4	+5 Volts	13.0 mV
5	+6 Volts	14.5 mV
6	+7 Volts	16.0 mV
7	+8 Volts	17.5 mV
8	+9 Volts	19.0 mV
9	+10 Volts	20.5 mV
10	+11 Volts	22.0 mV

¹COMPARISON VOLTAGE 10-turn dial set to 10-0 and Vc RANGE switch set to +11.

²The tabulated deviations are based on the accuracy specification of the comparison voltage: ±0.15% of indicated voltage plus ±0.05% (5.5 mV) of full Vc range. These deviations apply over the full environment range. When checking the unit in a laboratory environment, the deviation will be considerably smaller.

Calibration-Type 3A7

12. Check COMPARISON VOLTAGE 10-Turn Potentiometer Linearity

TABLE 5-2

- a. Set the COMPARISON VOLTAGE control to 0 (0-0-0) and check that the Vc RANGE switch is set to +11.
- b. Using the same connections as described in step 10c, use the non-loading voltmeter to check the comparison voltage for each major division of the COMPARISON VOLTAGE 10-turn dial: that is, at 0-1-0, 0-2-0, etc. Use Table 5-2 as a guide.
- c. Disconnect the voltmeter.

COMPARISON VOLTAGE ¹ Outer Knob Setting	Voltage Reading	Maximum Deviation from Null ²
1-0	+0.1 Volt	5.65 mV
2-0	+0.2 Volt	5.80 mV
3-0	+0.3 Volt	5.95 mV
4-0	+0.4 Volt	6.10 mV
5-0	+0.5 Volt	6.25 mV
6-0	+0.6 Volt	6.40 mV
7-0	+0.7 Volt	6.55 mV
8-0	+0.8 Volt	6.70 mV
9-0	+0.9 Volt	6.85 mV
10-0	+1.0 Volt	7.00 mV

13. Adjust AMP CAL R244

O

- a. Set the Type 3A7 controls as follows:
 Vc RANGE 0
 AC-DC-GND (A) DC
 DISPLAY A-B

¹COMPARISON VOLTAGE outer knob (switch) set to 0 and the Vc RANGE switch set to +11.

²Same as Table 5-1 footnote.

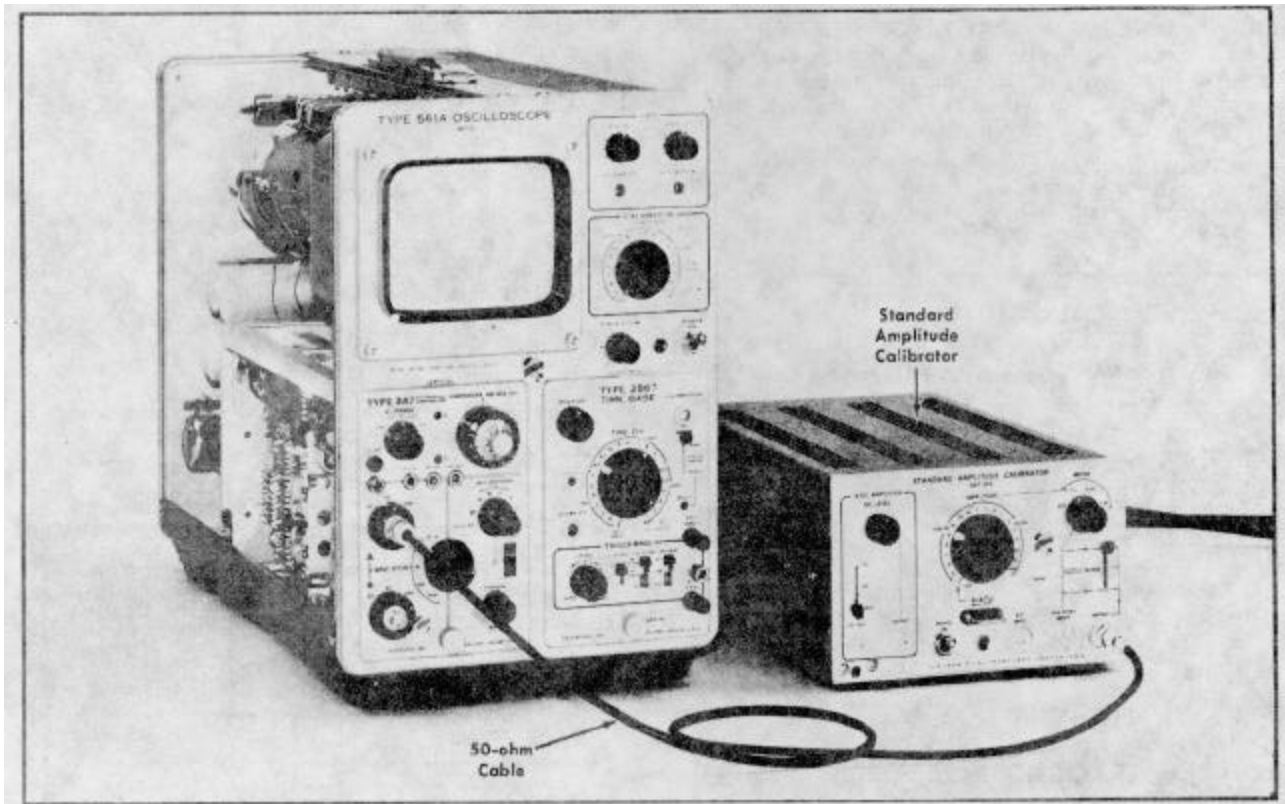

Fig. 5-14. Setup at completion of step 13c.

- b. If the previous steps have been performed, the remaining controls should be at the following positions:

Type 3A7
 COMPARISON VOLTAGE 0-10-0
 AC-DC-GND (B3) GND
 INPUT ATTEN 1

MILLIVOLTS/DIV
 VARIABLE
 POSITION 1
 CAL
 Midrange

Time Base
 Position Set so trace starts at left side of graticule.

Time/Div	.5 mSec
Variable	Calibrated
Pull 5X Mag	In
Mode	Norm
Level	Free Run
Slope	+
Coupling	AC Slow
Source	Int

c. Apply a 5mV peak-to-peak 1-kHz calibrator signal through a coaxial cable to the A input connector. If possible, use an accurate calibration signal source. Fig. 5-14 shows the setup.

d. Center the display using the Type 3A7 POSITION control.

e. Adjust the front-panel AMP CAL control (see Fig. 5-15) so the vertical deflection of the display is exactly 5 div peak to peak (see Fig. 5-16).

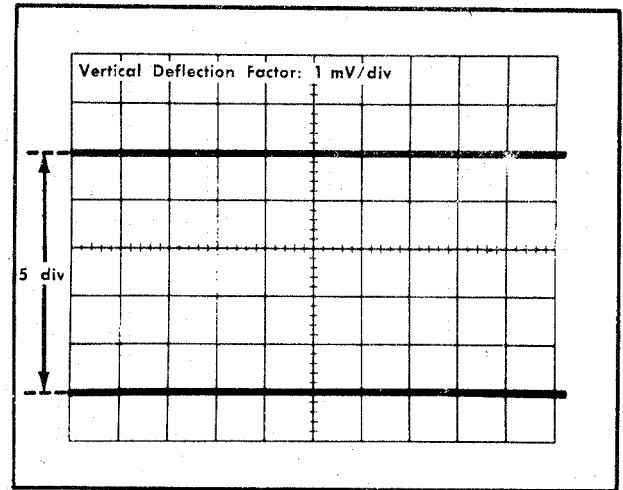

Fig. 5-16. Typical crt display showing correct gain adjustment.

14. Check VARIABLE (MILLIVOLTS/DIV) Control

a. Turn the VARIABLE control slowly counterclockwise. As the control moves out of the CAL position, a switch

b. When the VARIABLE control is set fully counterclockwise, check the amplitude of the display. It should be 1.6 div or less (see Fig. 5-17). This indicates a ratio of 2.5 to 1 or higher. For example, the amplitude of the display shown in Fig. 5-17 is 1.8 div which indicates a ratio of 2.78 to 1 ($5 + 1.8 = 2.78$) which is higher than 2.5 to 1.

c. Set the VARIABLE control to CAL.

15. Check MILLIVOLTS/DIV Switch

a. Using the same setup as shown in Fig. 5-14, check all the MILLIVOLTS/DIV switch positions for proper calibrated vertical-deflection factors. Use Table 5-3 as a guide. For all positions except the 1 mV/div position, the display amplitude tolerance should be within $\pm 3\%$ plus the tolerance of the amplitude calibrator output.

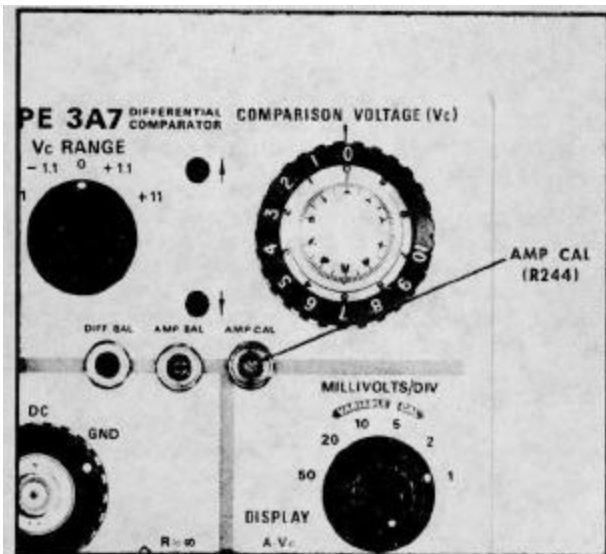

Fig. 5-15. Location of step 13e adjustment.

actuates which increases the display amplitude. Then, as the control is rotated further counterclockwise from that point on, the amplitude decreases. Check the control for smooth electrical and mechanical operation as the control is rotated counterclockwise in the amplitude range between 5 div and 2 div.

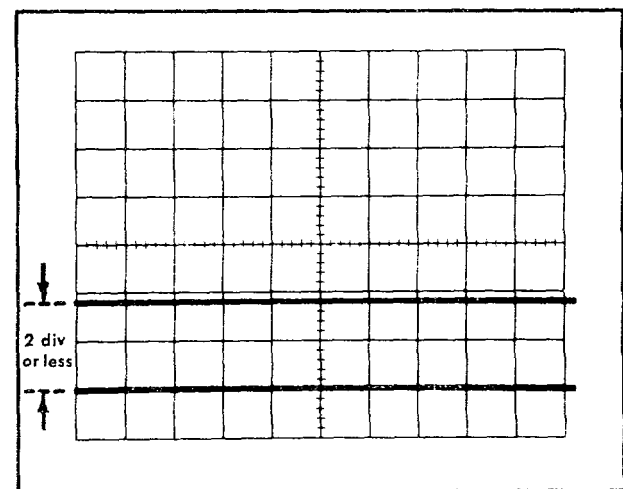

Fig. 5-17. Checking the VARIABLE control 2.5-to-1 uncalibrated range.

Calibration-Type 3A7

TABLE 5-3

MILLIVOLTS/DIV Switch Position	Amplitude Calibrator Output	Vertical Deflection in Div
2	10 mV	5
5	20 mV	4
10	50 mV	5
20	0.1 V	5
50	0.2 V	4

- b. Disconnect the calibrator signal.

16. Check Input CF Grid Current

- a. Set the Type 3A7 controls as follows:

AC-DC-GND (A)	GND
MILLIVOLTS/DIV	1

- b. Position the trace to graticule center using the Type 3A7 POSITION control. The remaining controls should be at the following positions:

Type 3A7

Vc RANGE	0
COMPARISON VOLTAGE	0-100
AC-DC-GND (B)	GND
INPUT ATTEN	1
DISPLAY	A-B
VARIABLE	CAL

Time Base

Position	Set so trace starts at left side of graticule
Time/Div	.5 mSec
Variable	Calibrated
Pull 5X Mag	In
Mode	Norm
Level	Free Run
Slope	+
Coupling	AC Slow
Source	Int

b. Set the input B AC-DC-GND switch to DC and note the amount of trace shift from graticule center. Trace shift should be less than 1 division, which is 1 nanoampere or less (1 mV divided by 1 MΩ input resistance equals 1 nanoampere).

c. Set the input B AC-DC-GND switch to GND and input A AC-DC-GND switch to DC. Note the amount of trace shift. It should be less than 1 div.

17. Check for Microphonics

- a. Set input A AC-DC-GND switch to GND.

b. Using the fingertips, tap lightly on top of the oscilloscope and check for microphonics. Overall amplitude of the microphonics should be less than 1 mV (less than 1 div).

18. Adjust DIFF BAL R216 and CF LOAD BALANCE R212



- a. Set the Type 3A7 controls as follows:

AC-DC-GND (A)	DC
INPUT ATTEN	100
MILLIVOLTS/DIV	50

- b. Set the time-base controls as follows:

Time/Div	10 mSec
Triggering Level	Auto

c. Apply a 30-volt (15 volts peak referenced to ground) 20-Hz sine-wave signal from an audio generator through a 42-inch coaxial cable, a BNC T connector and a dual-input connector (item 13) to the A and B input connector on the Type 3A7.

d. Connect a coaxial jumper cable and clip-lead adapter between the BNC T connector and the time-base Ext Input connector. If the time-base unit does not have a control for the external input, connect a 50,000-ohm potentiometer between the Ext Input connector and ground. Connect the center conductor clip lead to the potentiometer wiper arm. Fig. 5-18 shows the complete setup when a Type 2B67 is used as the time-base unit.

Calibration-Type 3A7

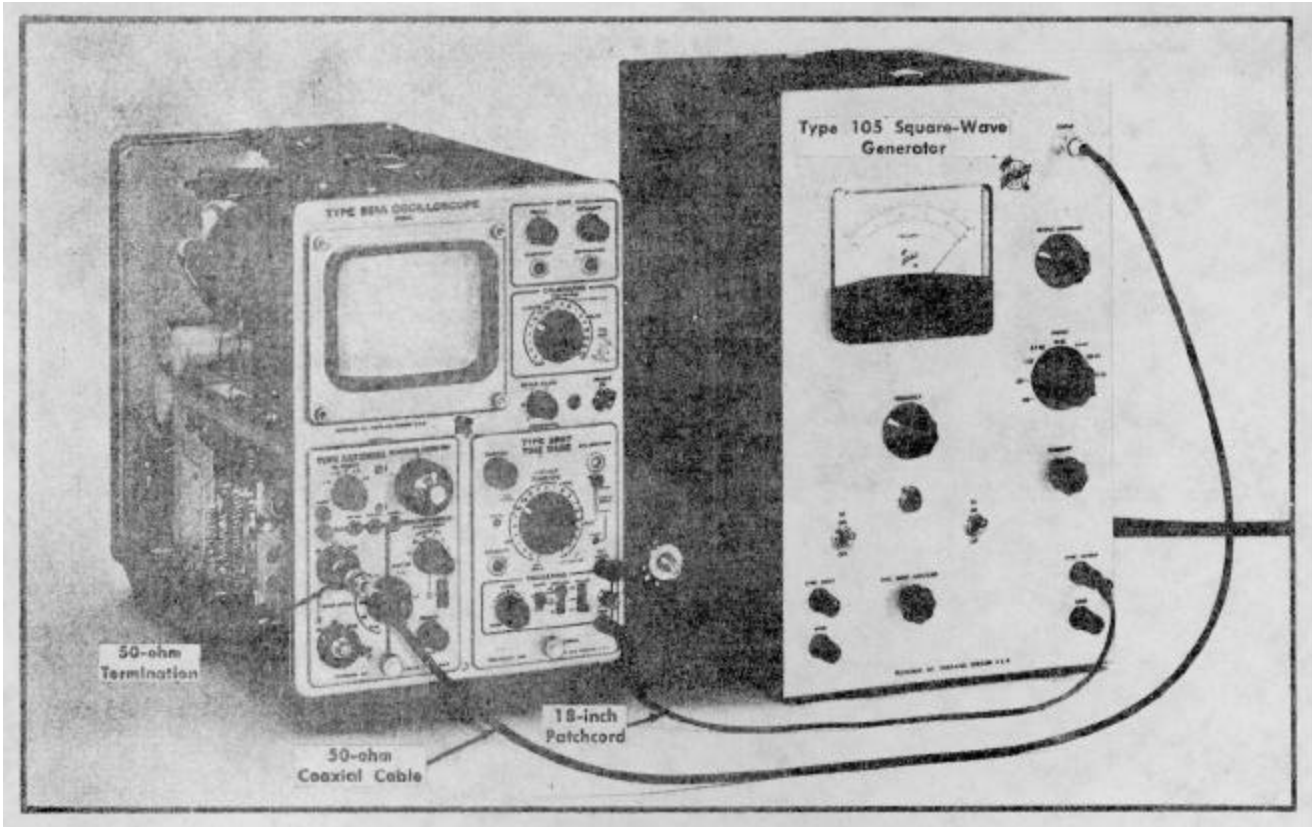

Fig. 5-18. Setup at completion of step 18d.

e. Check that the display is 30 volts in amplitude (6 div; see Fig. 5-19).

f. Set the Type 3A7 controls as follows:

AC-DC-GND (B)	DC
INPUT ATTEN	1
MILLIVOLTS/DIV	1

g. Set the time-base Time/Div switch to the Ext Input position. Adjust the Ext Input control so the horizontal deflection is about 6 div. Use the time-base Position control to center the display. The display should appear similar to the Fig. 5-20a illustration if the DIFF BAL R216 and CF LOAD BALANCE R212 controls are properly adjusted. Figs. 5-20b and 5-20c show two types of distortion obtained when these controls are improperly adjusted.

If the display is not a horizontal closed-loop display as shown in Fig. 5-20a, preset the DIFF BAL control R216 (see Fig. 5-21b to midrange and adjust the CF LOAD BALANCE control R212 (see Fig. 5-21a) so the closed loop lies in a horizontal plane. At this point, it is necessary to adjust these controls in small increments in a direction that will minimize the curvature of the display, as shown in Fig. 5-20a.

Alternative Method-When the time-base unit has no external input connector, proceed as follows:

Perform steps 180, b, c, e and f except that the BNC T connector, coaxial jumper cable and clip-lead adapter are not needed.

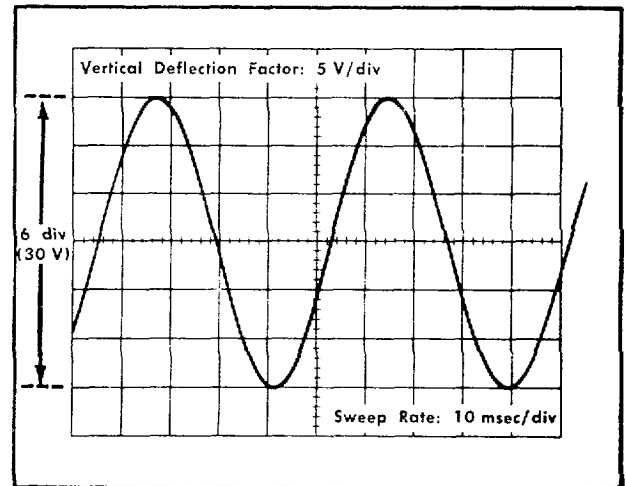

Fig. 5-19. Typical display obtained when audio generator is set for proper output, step 18e.

Calibration-Type 3A7

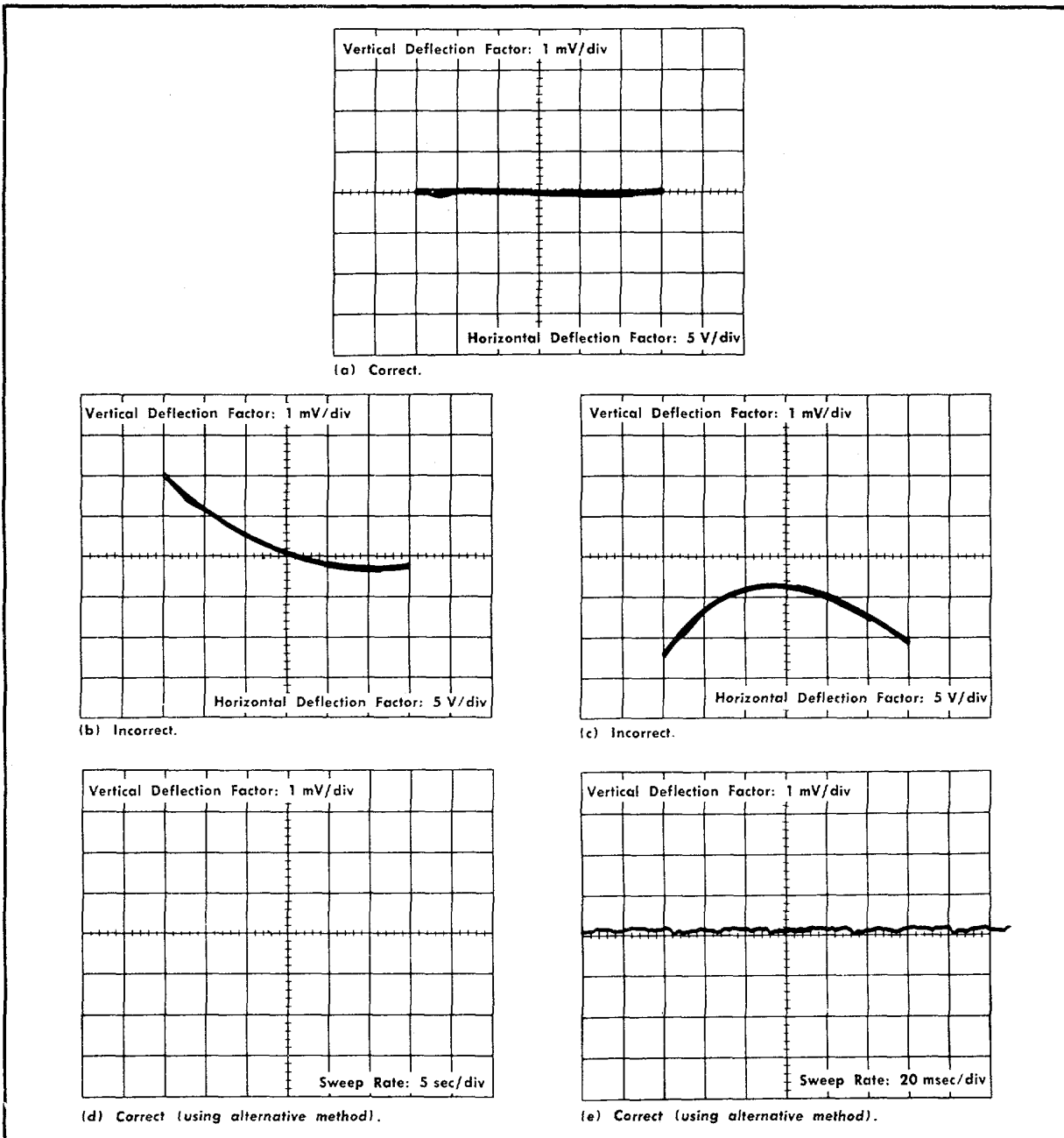

Fig. 5-20. Adjusting the DIFF BAL and CF LOAD BALANCE for optimum common-mode signal rejection at 20 Hz (dc coupled).

Set the time-base Time/Div and Variable controls for the slowest sweep.

Preset the DIFF BAL R216 to midrange and adjust the CF LOAD BALANCE control R212 until the amplitude of the slow moving beam is as small as possible: typically about 1.5 minor

div (see Fig. 5-20d). Fig. 5-20e shows the appearance of the display at a sweep rate of 20 msec/div.

h. Disconnect the audio generator connections from the Type 3A7 and time-base front panels. (Leave the 50,000-ohm potentiometer connected to the Type 2B67.)

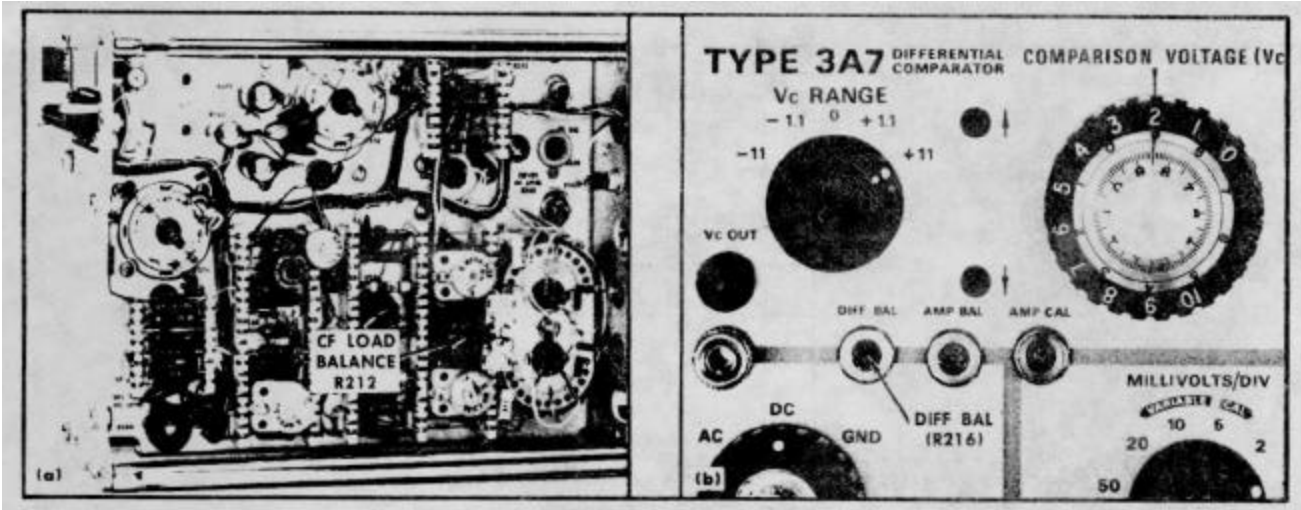

Fig. 5-21. Location of step 18 adjustments.

Calibration-Type 3A7

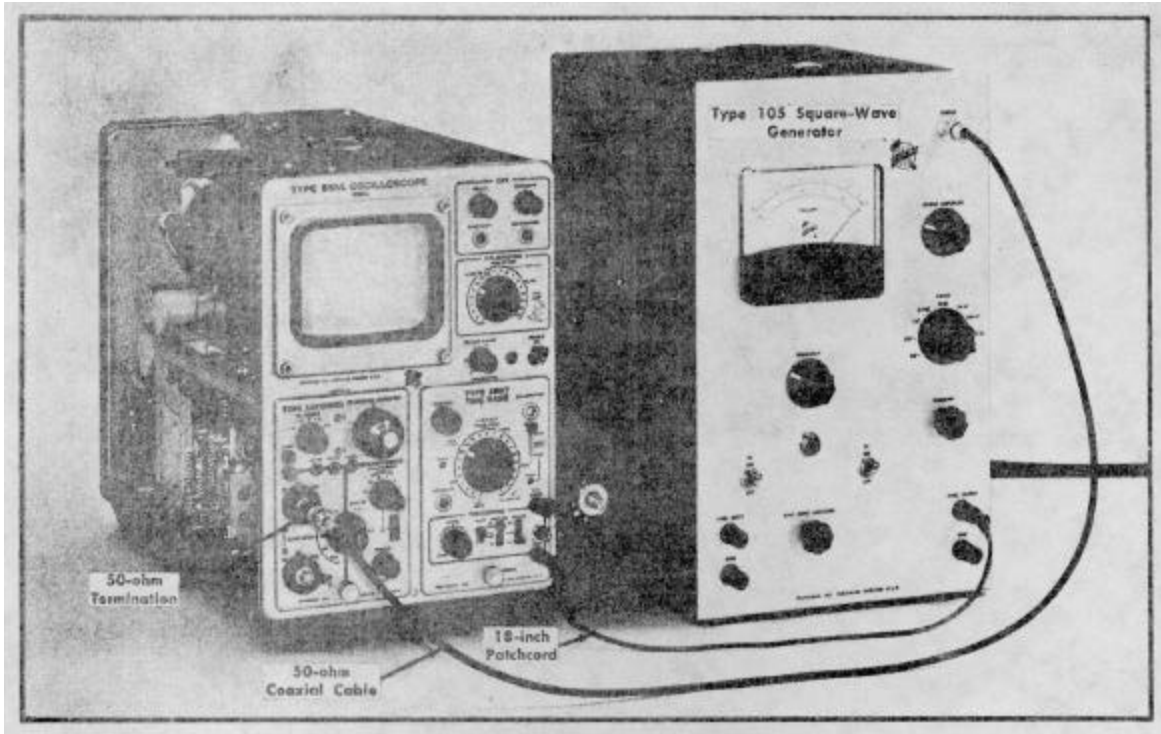

Fig. 5-22. Setup at completion of step 19c.

19. Adjust C120 (input A Overdrive Fast Recovery)



a. Set the Type 3A7 controls as follows:

AC-D-GND (B)	GND
INPUT ATTEN	100
MILLIVOLTS/DIV	20

b. Set the time-base Time/Div switch to 50 μ sec and the Triggering Source switch to Ext. At this point in the procedure, the remaining controls should be at the following positions:

Type 3A7

V _c RANGE	0
COMPARISON VOLTAGE	0-10-0
AC-DC-GND (A)	DC
DISPLAY	A-B
VARIABLE	CAL
POSITION	Midrange

Time Base

Position	Midrange
Variable	Calibrated
Pull 5X Mug	In
Mode	Norm
Level	Auto
Slope	+
Coupling	AC Slow

c. Apply a 10-kHz signal from the Type 105 Square-Wave Generator, or equivalent, through a 50-ohm coaxial cable and a 50-ohm termination to the Type 3A7 input A connector. Connect an 8-inch patch cord between the Type 105 Sync Output connector and the time-base Ext Trig connector. Fig. 5-22 shows the complete setup.

d. Adjust the square-wave generator Output Amplitude control so the display is 5 div (10 volts peak to peak) in amplitude. Use the positioning controls to position the display (see Fig. 5-23a) for best viewing.

e. Set the Type 3A7 controls as follows:

INPUT ATTEN	1
MILLIVOLTS/DIV	50

f. Set the time-base Time/Div switch to 20 μ Sec. Set the Triggering Level control so the upper front corner on the first cycle is displayed like the corner of the second cycle (see Fig. 5-23b).

g. Set the MILLIVOLTS/DIV switch to 10 and set the time-base Time/Div switch to 10 μ Sec.

h. Position the first cycle so the trailing portion of the waveform coincides with graticule center (see Fig. 5-23c). Leave the Type 3A7 POSITION control at this setting until you have checked overdrive fast recovery described in the first paragraph of step 19j.

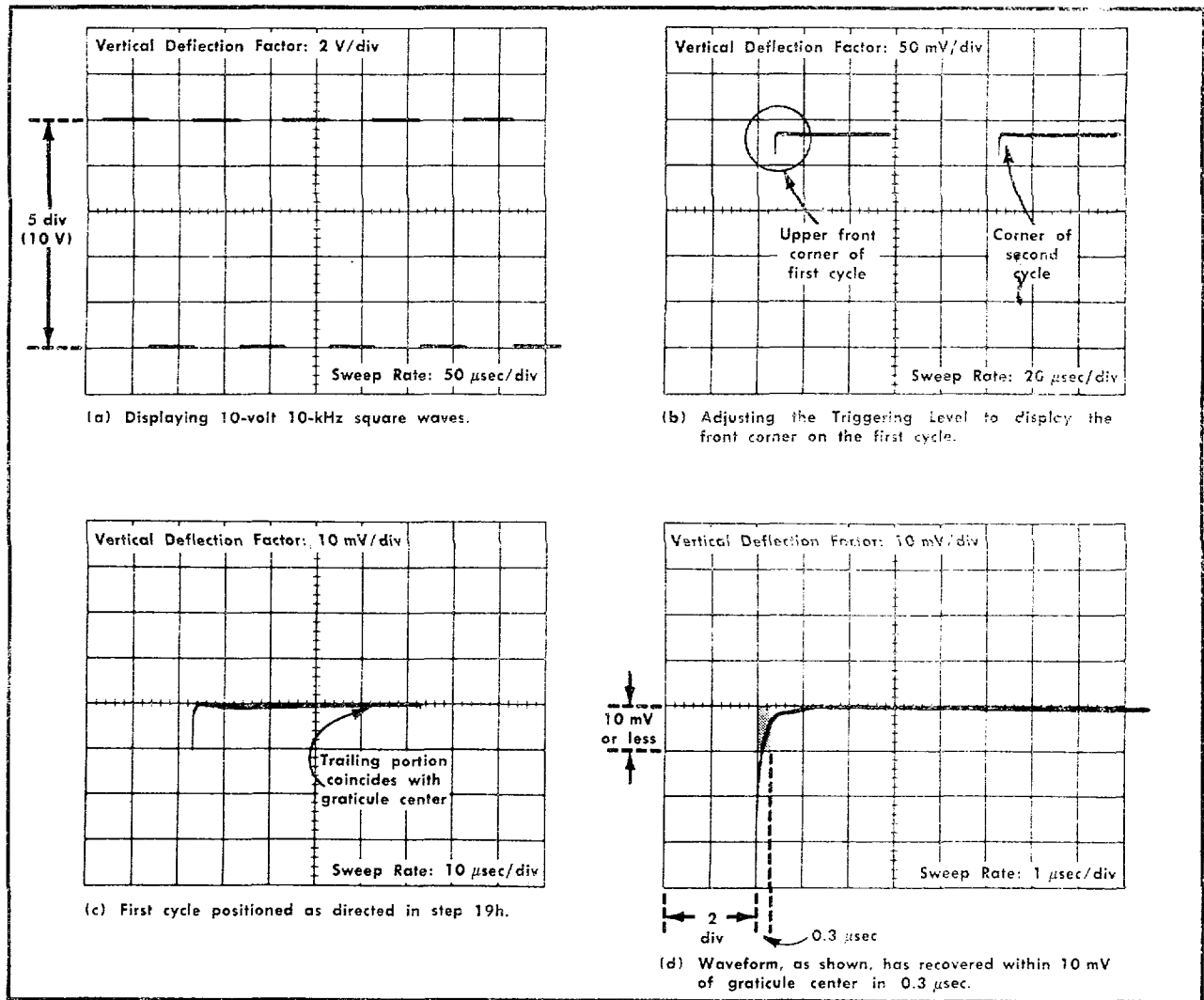

Fig. 5-23. Typical displays obtained when performing steps 19d through j.

i. Set the time-base Time/Div switch to 5 μSec and set the Pull 5X Mag switch to its outward position for 5X magnification. Using the time-base Position control, position the waveform to start two div from the left edge of the graticule (see Fig. 5-23d).

j. Check overdrive fast recovery by observing that the waveform returns to within 10 mV of graticule center in a time duration of 0.3 μs. Fig. 5-23d is a typical display that has recovered within the 10-mV requirement.

NOTE

If the time base you are using will display the waveform when using faster sweep rates up to 0.1 μs/div, use a faster sweep rate to check overdrive fast recovery.

If overdrive recovery is within the 10-mV requirement, go to the next step. If overdrive recovery is greater than 10 mV, set the MILLIVOLTS/DIV switch to 5. Then set the time-base Time/Div switch to 20 μSec and push the Pull 5X Mag switch to its inward position. Position the display for best viewing. Adjust C120 (see Fig. 5-24) so the peak and the dip that follows the peak are equal in amplitude with respect to the waveform reference level at the point shown in Fig. 5-25a.. One waveform showing the result obtained when C120 is incorrectly adjusted is shown in Fig. 5-25b. Repeat steps 19g through j to recheck the input A overdrive fast recovery.

20. Check Input A Overdrive Dc Shift

- a. Set the input A AC-DC-GND switch to GND.
- b. Set the time-base Time/Div switch to 50 μSec and the Triggering Level to Auto.

Circuit Description-Type 3A7

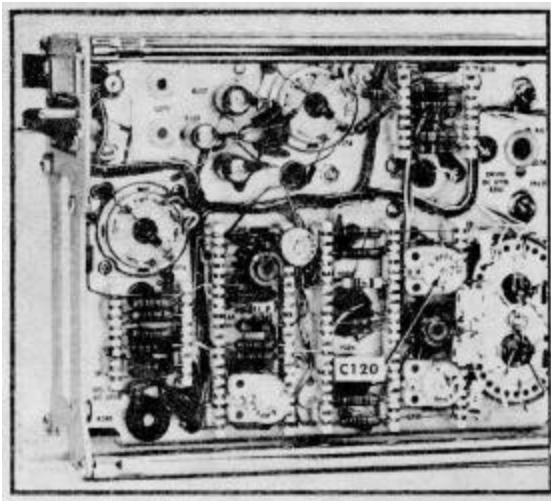

Fig. 5-24. Step 19i adjustment location.

c. Using the Type 3A7 POSITION control, position the trace to graticule center.

d. Set the input A AC-DC-GND switch to DC. Check the position of the display. The trailing portion of each cycle should be within 5 mV (1 div) or less with respect to graticule center one second after the switch was set to DC (see Fig. 5-26)

e. Set the square-wave generator DC switch to Off and disconnect the generator connections at the Type 3A7 and time-base front panels. (This generator setup will be used again to perform steps 22 and 23.)

21. Adjust C113, C213 and C220 (Common-Mode Rejection at 20 kHz)

a. Set the Type 3A7 controls as follows:

INPUT ATTEN	100
MILLIVOLTS/DIV	50

b. Set the time-base Triggering Source switch to Int.

c. Apply a 30-volt (15 volts peak referenced to ground), 20-kHz sine-wave signal from the audio generator through a 42-inch coaxial cable, BNC T connector and dual-input connector to the A and B input connectors on the Type 3A7.

d. Connect a coaxial jumper cable and clip-lead adapter between the BNC T connector and the time-base Ext Input connector. This is the same setup as shown in Fig. 5-18. (If a Type 2B67 is used, connect the clip-lead adapter to the 50,000-ohm potentiometer as shown in the illustration.)

e. Check that the amplitude of the display is 30 volts (6 div; see Fig. 5-27a).

f. Set the Type 3A7 controls as follows:

AC-DC-GND (B)	DC
INPUT ATTEN	1
MILLIVOLTS/DIV	1

g. Set the time-base Time/Div switch to the Ext Input position and set the horizontal deflection so it is about 6 div.

h. Check for a closed-loop horizontal display as shown in Fig. 5-27b. If the display is obtained, go to step 22. If the proper display is not obtained (see Fig. 5-27c), adjust C220 (Fig. 5-28) so the loop is horizontal and adjust C113 and C213 (Fig. 5-28) to close the loop. These adjustments interact so they must be adjusted a small amount at a time until the loop is closed and is horizontal. Check that the adjustments are set correctly when the left side panel is installed temporarily. If necessary, readjust C113, C213 and C220 to compensate for the change.

Alternative Method - If the time-base has no external input provision, proceed as follows:

Perform steps 210a through f except that the BNC T connector, jumper cable and clip-lead adapter are not used. Carefully adjust C113, C213 and C220 to obtain a minimum

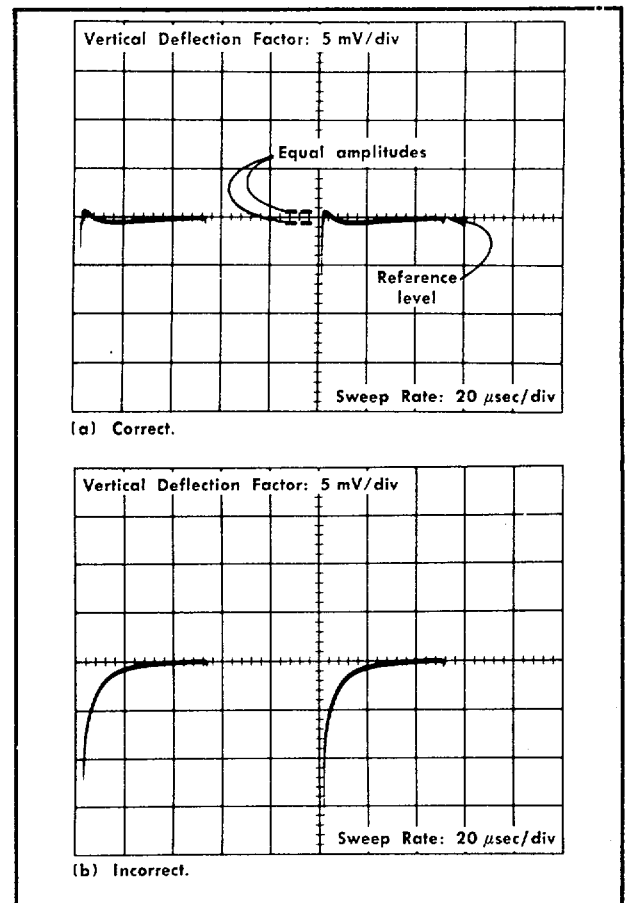

Fig. 5-25. (a) Correct display obtained when C120 is properly adjusted, and (b) shows one example of incorrect adjustment.

amplitude display. Fig. 5-27d shows a typical display that can be used as a guide. Install side panel temporarily. Check that the adjustments are set correctly; readjust if necessary.

i. Set the Time/Div switch to 50 μ Sec (continued from step 21h, first paragraph) and check the display amplitude (see Fig. 5-27d). It should be 1.5 mV or less peak to peak. This fulfills the 20,000:1 common-mode rejection ratio (CMRR) requirement (30 volts divided by 1.5 mV equals 20,000).

j. Disconnect the audio generator connections from the Type 3A7 and time-base front panels. (This generator setup will be used again to perform step 24.)

22. Check Input B Overdrive Fast Recovery

a. Set the Type 3A7 controls as follows:

AC-DC-GND (A)	GND
MILLIVOLTS/DIV	50

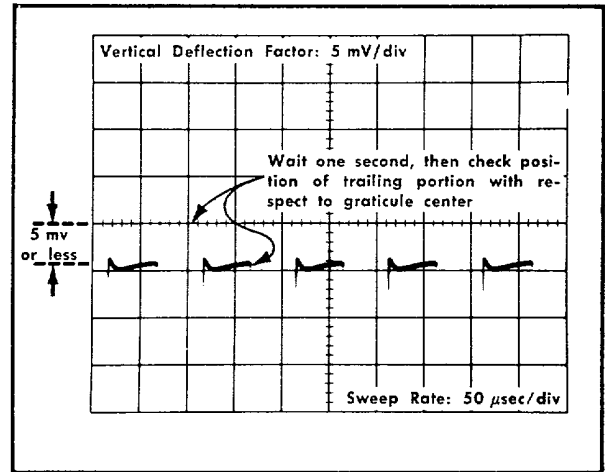

Fig. 5-26. Checking input A overdrive dc shift.

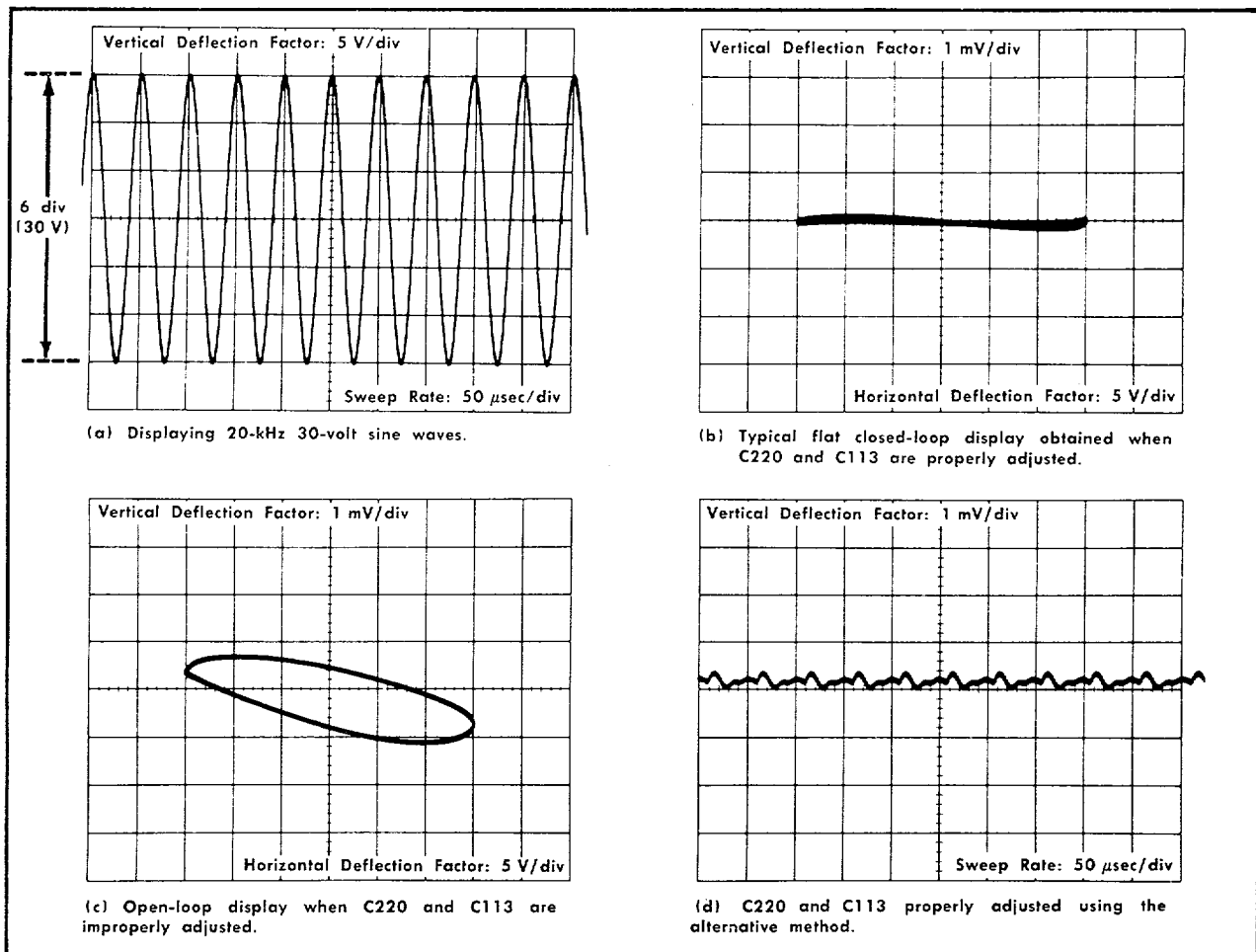

Fig. 5-27. Typical displays obtained when performing step 21.

Circuit Description-Type 3A7

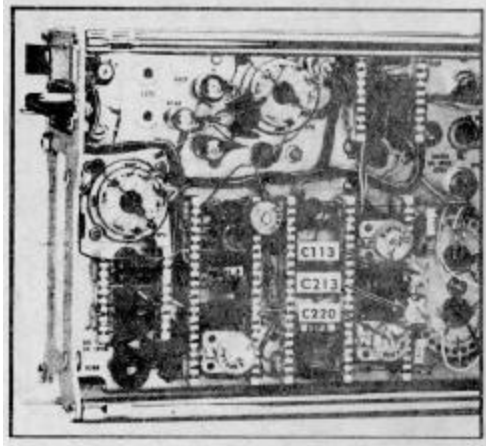

Fig. 5-28. Step 21h adjustment locations.

b. Apply the 10-kHz signal from the square-wave generator through the coaxial cable and termination to the Type 3A7 input B connector. Connect the generator sync output patch cord to the time-base Ext Trig connector. Set the generator DC switch to On. (This is the same setup as shown in Fig. 5-22, except the 10-kHz 10-volt signal is applied to input B.

c. Set the time-base controls as follows:

Time/Div	20 μ Sec
Triggering Source	Ext

d. Set the time-base Triggering Level controls so the front corner on the first cycle of the waveform can be seen clearly. This display is similar to Fig. 5-23b, but inverted.

e. Set the MILLIVOLTS/DIV switch to 10 and the time-base Time/Div switch to 10 μ Sec.

f. Position the first cycle so the trailing portion of the waveform coincides with graticule center (see Fig. 5-29a). Leave the Type 3A7 POSITION control at this setting until the overdrive recovery check described in step 22h has been made.

g. Set the time-base Time/Div switch to 5 μ Sec and set the Pull 5X Mag switch to its outward position. Position the waveform to start two div from the left edge of the graticule (see Fig. 5-29b). This waveform is similar to Fig. 5-24d, but inverted.

h. Check overdrive fast recovery by observing that the waveform returns to within 10 mV of graticule center in a time duration of 0.3 μ s. Fig. 5-29b shows how to determine whether this requirement is met.

NOTE

If the time base you are using will display the waveform when using faster sweep rates up to 0.1 μ s/div, then use a faster sweep rate to check overdrive fast recovery.

23. Check Input B Overdrive Dc Shift

a. Set input B AC-DC-GND switch to GND and set the MILLIVOLTS/DIV switch to 5.

b. Set the time-base Time/Div switch to 50 μ Sec, push the Pull 5X Mag switch to its inward position and set the Triggering Level control to AUTO.

c. Position the trace to graticule center.

d. Set the input B AC-DC-GND switch to DC. Wait one second and check the position of the display. The trailing portion of each cycle should be within 5 mV (1 div) or less from graticule center (see Fig. 5-30).

e. Disconnect the square-wave generator.

24. Check Sine-Wave Common-Mode Rejection Requirements

a. Set the Type 3A7 controls as follows

INPUT ATTEN	100
MILLIVOLTS/DIV	50

b. Set the time-base controls as follows

Time/Div	5 mSec
Triggering Level	Auto
Triggering Source	Int

At this point in the procedure, the remaining controls should be at the following positions:

Type 3A7	
Vc RANGE	0
COMPARISON VOLTAGE	0-10-0
AC-DC-GND (A)	GND
AC-DC-GND (B)	DC
DISPLAY	A-B
VARIABLE	CAL
POSITION	Midrange
Time Base	
Position	Midrange
Variable	Calibrated
Pull 5X Mag	In
Mode	Norm
Slope	+
Coupling	AC Slow

c. Apply a 30-volt (15 volts peak reference to ground), 60-Hz sine-wave signal from the audio generator through the coaxial cable, BNC T connector and dual-Input connector to the A and B input connectors on the Type 3A7.

d. Connect a coaxial jumper cable and clip-lead adapter from the BNC T connector to the time-base Ext Input connector. This is the same setup as shown in Fig. 5-18. (If the Type 2B67 is used, connect the clip-lead adapter to the 50,000-ohm potentiometer as shown in the illustration.)

e. Check that the amplitude of the display is 30 volts. (Same amplitude as shown in Fig. 5-19.)

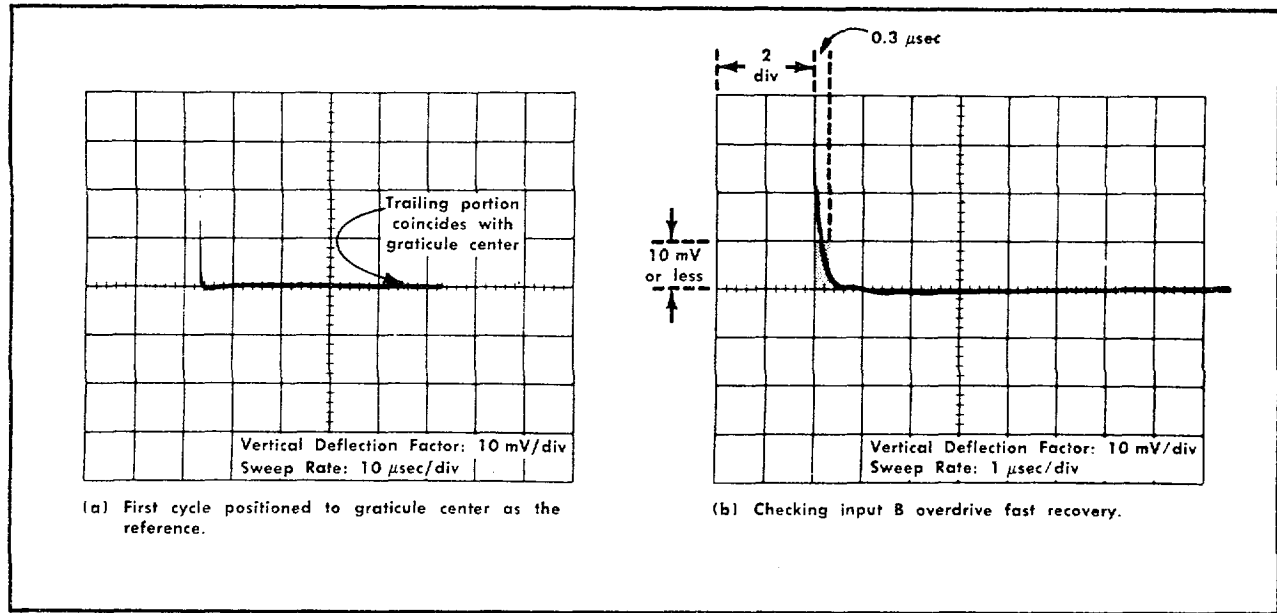

Fig. 5-29. Displays obtained when performing step 22.

f. Set the Type 3A7 controls as follows:

AC-DC-GND (A)	AC
AC-DC-GND (B)	AC
INPUT ATTEN	1
MILLIVOLTS/DIV	10

g. Set the time-base Time/Div switch to the Ext Input position. Install the left side panel on the oscilloscope.

h. Check the display amplitude. It should be 30 mV or less (see Fig. 5-31) to obtain a CMRR requirement of 1000:1 for ac-coupled 60-Hz sine waves.

i. Using this procedure as a pattern for setting up the common-mode signal amplitude applied to the connectors and using the information given in Table 5-4, check the CMRR for sine waves that are dc coupled. (To dc couple the common-mode signal when checking CMRR, set both AC-DC-GND switches to DC.)

TABLE 5-4
SINE-WAVE COMMON-MODE REJECTION
(Dc-coupled)

Common-Mode P-P Input Voltage	Input Voltage Sine-Wave Frequency	Common-Mode Rejection Ratio Requirement	Maximum Display Amplitude
30 V	200 Hz	20,000:1	1.5 mV ¹
30 V	2 kHz	20,000:1	1.5 mV ¹
30 V	500 kHz	500:1	60 mV ²

¹Set MILLIVOLTS/CM switch to 1.

²Set MILLIVOLTS/CM switch to 20.

j. Disconnect the audio generator including all accessories. Remove the left side panel from the oscilloscope.

25. Check DC Common-Mode Rejection

a. Set the time-base Time/Div switch to .5 mSec.

b. Set the COMPARISON VOLTAGE switch to 10.00 (9-10-0).

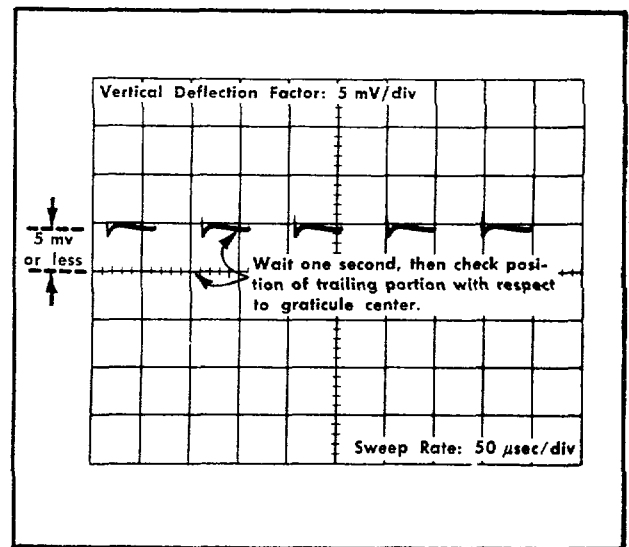

Fig. 5-30. Checking Input B overdrive dc shift.

Circuit Description-Type 3A7

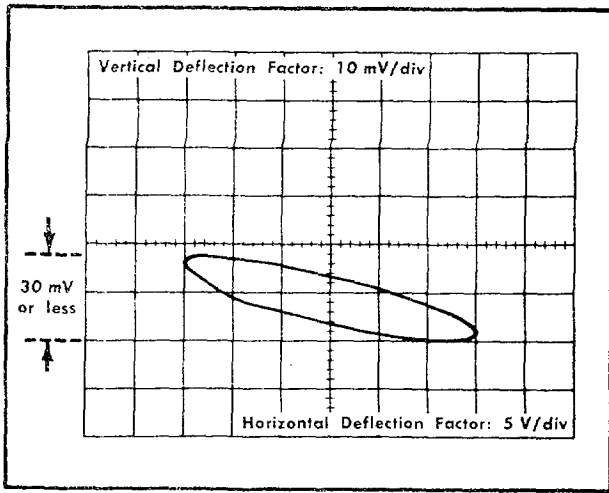

Fig. 5-31. Checking common-mode rejection by applying 60-Hz sine waves ac coupled to the Type 3A7 and measuring the X-Y display vertical amplitude.

c. Check that these controls are set as follows:

Vc RANGE	0
AC-C-GND (A and B)	DC
INPUT ATTEN	1
DISPLAY	A-B
MILL/VOLTS/DIV	1

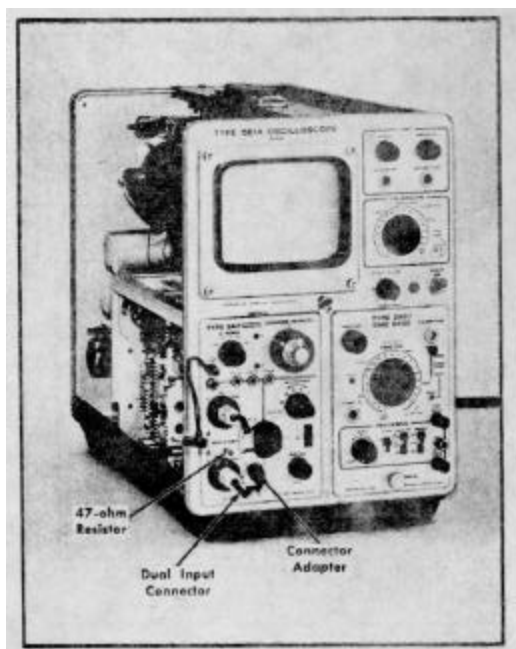

Fig. 5-32. Setup at completion of step 25d.

d. Connect the Vc OUT jack through a 47-ohm resistor to both A and B input connectors. To make the connections, use the dual input BNC connector, a connector

adapter and a 6-inch jumper lead with a tip plug. The 47-ohm resistor prevents oscillations from occurring. Fig. 5-32 shows the setup.

e. Position the trace to coincide with graticule center to establish a reference.

f. Set the Vc RANGE switch to +11 and note the position of the trace. The difference between the trace positions in step e and this step should not be any greater than 0.5 div to obtain a dc common-mode rejection ratio of 20,000:1.

NOTE

To double-check the trace positions, set the Vc RANGE switch to 0 and then back to + 11. Note the amount of trace shift.

g. Set the Vc RANGE switch to 0 and check that the trace coincides with graticule center.

h. Set the Vc RANGE switch to -11. The difference between the position of the trace when the Vc RANGE switch is set to 0 and when it is set to -11 should not be greater than 0.5 div.

i. Set the Vc RANGE switch to 0.

j. Disconnect the dual input connector, 47-ohm resistor, connector adapter and jumper lead.

26. Adjust R106E (Input A 10X Attenuator)

a. Set the Type 3A7 controls as follows:

COMPARISON VOLTAGE	Fully clockwise (10-10-past 0)
AC-DC-GND (B)	GND
INPUT ATTEN	10
DISPLAY	A-Vc

At this point in the procedure, the remaining controls should be at the following positions:

	Type 3A7
Vc RANGE	0
AC-DC-GND (A)	DC
MILLIVOLTS/DIV	1
VARIABLE POSITION	CAL Midrange
	Time Base
Position	Set so trace starts at left side of graticule
Time/Div	.5 mSec
Variable	Calibrated
Pull 5X Mag	In
Mode	Norm
Level	Auto
Slope	+
Coupling	AC Slow
Source	Int

Circuit Description-Type 3A7

b. Connect a connector adapter to the A input connector. Connect a $0.001\ \mu\text{F}$ capacitor between the A input connector adapter and ground to reduce noise pickup.

c. Connect a short jumper lead from the A input connector adapter to TP420 (see Fig. 5-33).

d. Connect a short patch cord from the A input connector adapter to the Precision Dc Divider (item 9) Voltage Input connector.

e. Connect a short patch cord from the Precision Dc Divider Gnd connector to the Type 3A7 ground binding post.

f. Connect a $1\text{-M}\Omega$ (1%) resistor from the Precision Dc Divider Voltage Output connector to the Gnd connector.

g. Connect a short patch cord (equipped with a tip plug) from the Precision Dc Divider Voltage Output connector to the Vc OUT jack.

h. Set the Precision Dc Divider 10:1-100:1 switch to 10:1. Fig. 5-34 shows a close-up view of the setup.

i. Using the POSITION control, position the trace to coincide with graticule center.

j. Set the COMPARISON VOLTAGE control outer knob (switch) to a position between the 10 and 9 detent positions. (The switch internally disconnects the comparison voltage from the Vc OUT jack and amplifier. However, externally the divider voltage will be applied via the jumper lead to the Vc OUT lack.

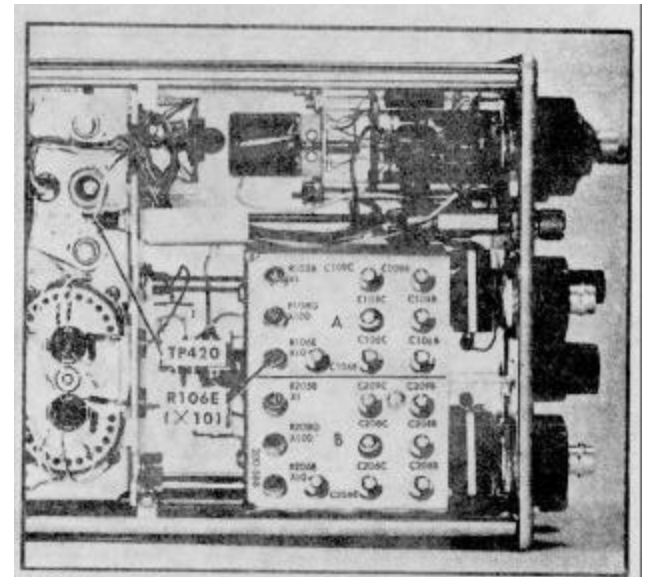

Fig. 5-33. Location of step 26 test point and adjustment.

This voltage will then be applied internally from the Vc OUT jack through the DISPLAY switch to the B input grid side of the Type 3A7 amplifier.)

k. Set the Vc RANGE switch to +11.

l. Adjust R106E (see Fig. 5-33) so the trace is returned to graticule center.

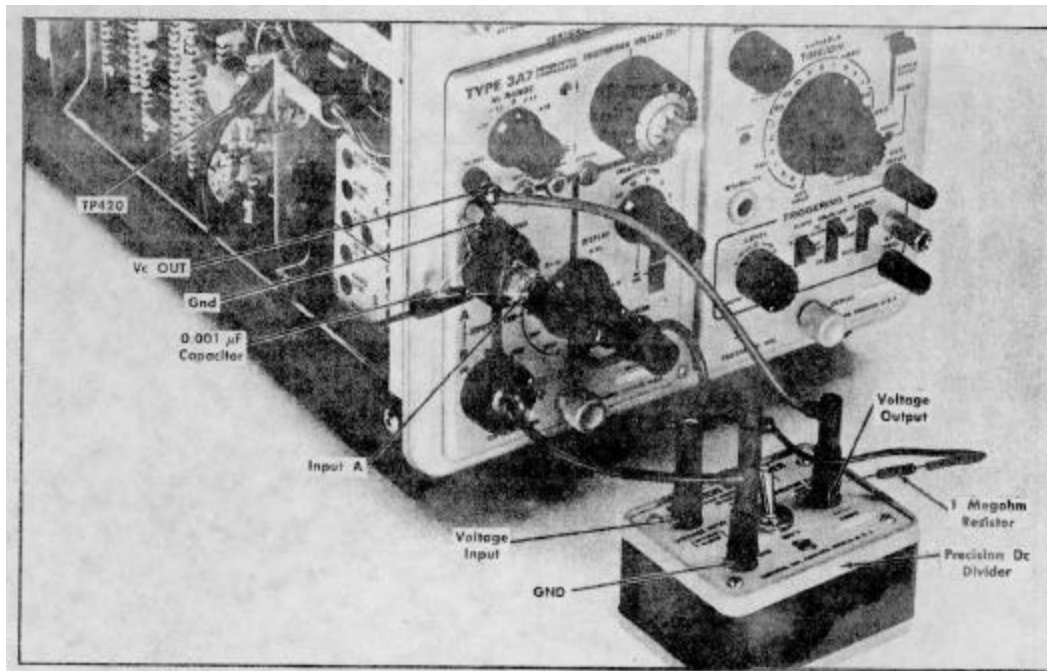

Fig. 5-34. Setup at completion of step 26h.

Circuit Description-Type 3A7

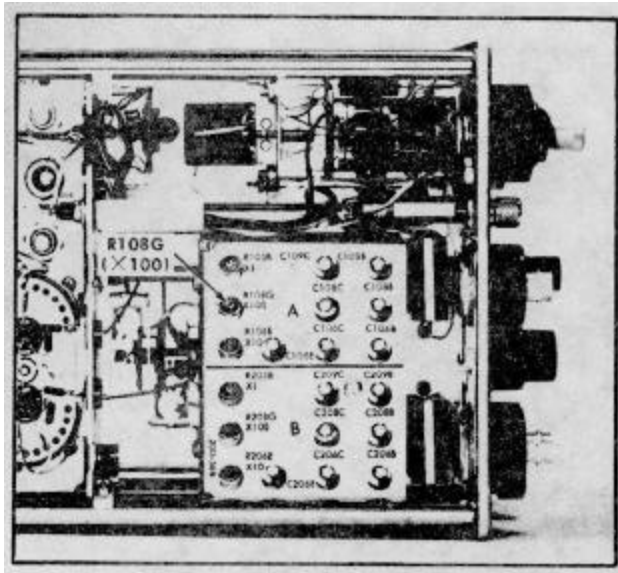

Fig. 5-35. Location of step 27 adjustment.

27. Adjust R108G (Input A 100X Attenuator)

a. Set the Type 3A7 controls as follows:

Vc RANGE	0
COMPARISON VOLTAGE (Outer knob)	10
INPUT ATTEN	100

b. Set the Precision Dc Divider 10:1-100:1 switch to 100:1.

c. Check that the trace is centered.

NOTE

When using a deflection factor of 1 mV/div and the trace drifts slightly from graticule center, use the DC BAL control as a positioning control, if desired, for steps requiring the trace to remain centered.

d. Set the COMPARISON VOLTAGE control outer knob between the 10 and 9 detent positions; set the Vc RANGE switch to +11.

e. Adjust R108G (see Fig. 5-35) so the trace coincides with graticule center.

f. Set the Vc RANGE switch to 0 and the COMPARISON VOLTAGE control outer knob to 5.

g. Leave the jumper connected that connects from TP420 to the A input connector. Leave the 0.001 μ F capacitor connected as is. Disconnect all other patch cords at the ends that connect to the Type 3A7, but leave the other ends of the cords connected to the Precision Dc Divider as they are because the setup will be used again later.

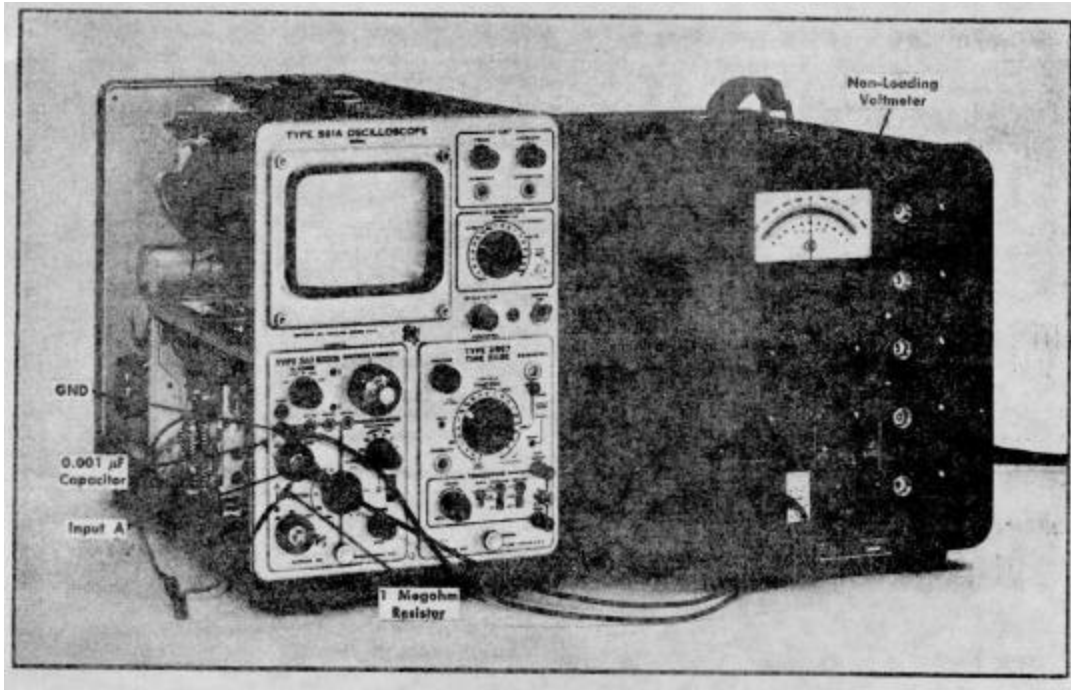

Fig. 5-36. Setup at completion of step 28e.

28. Adjust R105B (Input A 1X Attenuator)



a. Insert the 1-MΩ (1%) resistor between the jumper and the A input connector adapter.

b. Set the Type 3A7 controls as follows:

INPUT ATTEN	10
Vc RANGE	+1.1

c. Rotate the COMPARISON VOLTAGE control to position the trace to graticule center. The control setting will be near +0.55V (5-5-0). Leave the control at this setting until step 28g is completed.

d. Connect a non-loading voltmeter between input A connector adapter and ground.

e. Set the non-loading voltmeter to obtain a null reading (at about 5.5 volts). Fig 5-36 shows the setup.

f. Set the INPUT ATTEN switch to 1 and the Vc RANGE switch to +11.

g. Adjust R105B (see Fig. 5-37) to obtain a null reading on the non-loading voltmeter.

h. Disconnect the voltmeter.

29. Adjust R206E Input B 10X Attenuator



a. Set the Type 3A7 controls as follows:

Vc RANGE	0
----------	---

COMPARISON VOLTAGE

Fully clockwise
(10-10-past 0)

AC-DC-GND (A)

GND

AC-DC-GND (B)

DC

INPUT ATTEN

10

DISPLAY

Vc-B

b. Remove the 1-MΩ resistor and 0.001 μF capacitor. Connect the jumper lead and connector adapter to the B input connector. Reconnect the 0.001 μF capacitor between the B input connector adapter and ground. (With resistor removed, the jumper lead is now connected between TP420 and the B input connector. The 0.001 μF capacitor is used to reduce noise pick-up at the B input connector.)

c. Connect a short patch cord from the B input connector adapter to the Precision Dc Divider Voltage Input connector.

d. Connect a short patch cord from the Precision Dc Divider Gnd connector to the Type 3A7 ground binding post.

e. Connect the 1-MΩ resistor from the Precision DC Divider Voltage Output connector to the Gnd connector.

f. Connect a short patch cord (equipped with a tip plug) from the Precision Dc Divider Voltage Output connector to the Vc OUT jack.

Circuit Description-Type 3A7

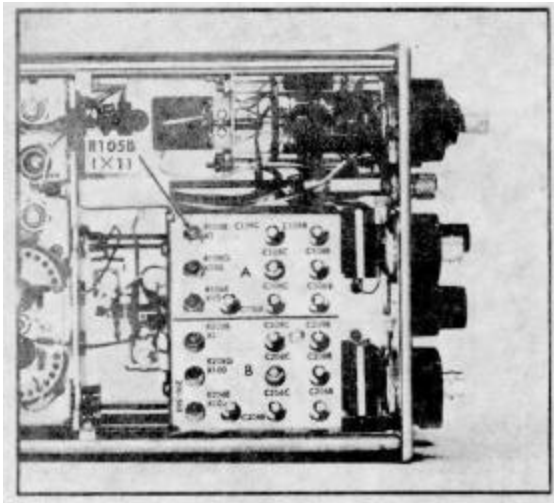

Fig. 5-37. Location of step 28g adjustment.

g. Set the Precision Dc Divider 10:1-100:1 switch to 10:1. (This is the same setup as shown in Fig. 5-34 except the B input connector is used.)

h. Check that the trace is centered.

i. Set the COMPARISON VOLTAGE control outer knob to a position between the 10 and 9 detent positions and set the Vc RANGE switch to +11.

j. Adjust R206E (see Fig. 5-38) so the trace is returned to graticule center.

30. Adjust R208G (Input B 100X Attenuator)

a. Set the Type 3A7 controls as follows:

Vc RANGE	0
COMPARISON VOLTAGE (Outer knob)	10
INPUT ATTEN	100

b. Set the Precision Dc Divider 10:1-100:1 switch to 100:1.

c. Check that the trace is centered.

d. Set the COMPARISON VOLTAGE control outer knob between the 10 and 9 detent positions; set the Vc RANGE switch to +11.

e. Adjust R208G (see Fig. 5-38) to center the trace.

f. Set the Vc RANGE switch to 0 and the COMPARISON VOLTAGE outer knob to 5.

g. Leave the jumper connected that connects from TP420 to the B input connector. Leave the 0.001 μ F capacitor connected as is. Disconnect all other patch cords from the Type 3A7 to disconnect the Precision Dc Divider.

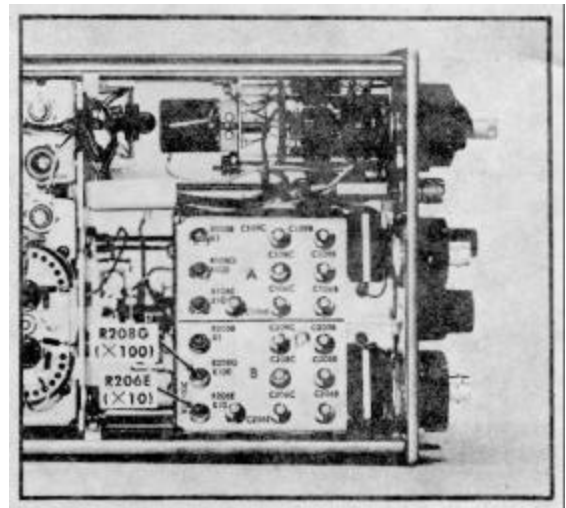

Fig. 5-38. Steps 29j and 30e adjustment locations.

31. Adjust R205B (Input B 1X Attenuator)

a. Insert the 1-M Ω resistor between the jumper and the B input connector adapter.

b. Set the Type 3A7 controls as follows:

INPUT ATTEN	10
Vc RANGE	+1.1

c. Rotate the COMPARISON VOLTAGE control to position the trace to graticule center. The control setting will be near +0.55V (5-5-0). Leave the control at this setting until step 31g is completed.

d. Connect a non-loading voltmeter between input B connector and ground.

e. Set the non-loading voltmeter to obtain a null reading (about 5.5 volts). This is the same setup as Fig. 5-36 except the connections are made to input B.

f. Set the INPUT ATTEN switch to 1 and the Vc RANGE switch to +11.

g. Adjust R205B (see Fig. 5-39) to obtain a null reading on the non-loading voltmeter.

h. Set the Vc RANGE switch to 0.

i. Disconnect the voltmeter, resistor, capacitor, jumper lead and connector adapter.

32. Check Input B 1000X Attenuator

a. Set the Type 3A7 controls as follows:

INPUT ATTEN	1000
DISPLAY	A-B

Circuit Description-Type 3A7

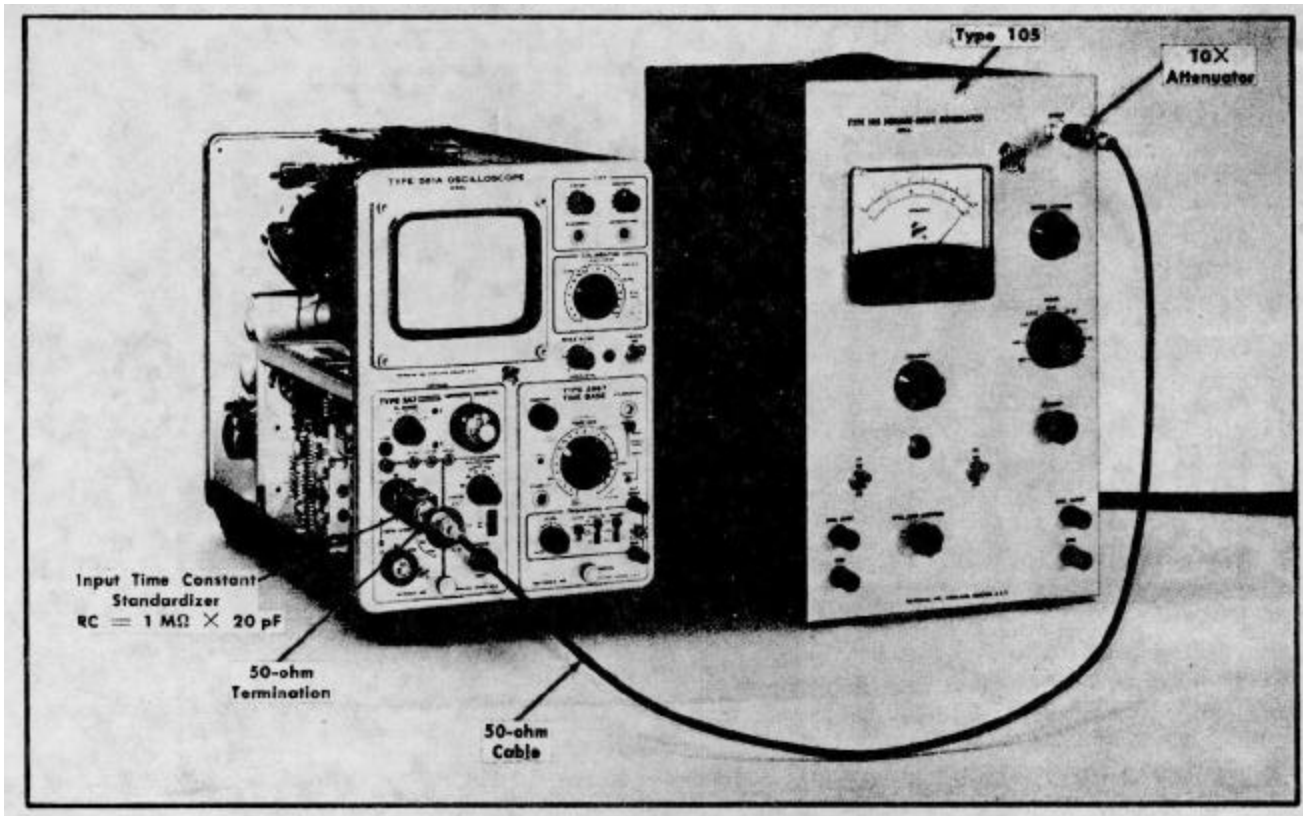

Fig. 5-40. Setup a completion of step 34b.

34. Adjust Input Attenuator Compensation

O

a. Set the Type 3A7 controls as follows:

INPUT ATTEN	1
MILLIVOLTS/DIV	50

Variable	Calibrated
Pull 5X Mag	In
Mode	Norm
Level	Auto
Slope	+
Coupling	AC Slow
Source	Int

Up to this point in the procedure, the remaining controls should be at the following positions:

Type 3A7

Vc RANGE	0
COMPARISON VOLTAGE	As is
AC-DC-GND (A)	DC
AC-DC-GND (B)	GND
DISPLAY	A-B
VARIABLE POSITION	CAL
	Trace positioned to graticule center

Time Base

Position	Set so trace starts at left side of graticule
Time/Div	.5 mSec

b. Apply a 1-kHz signal from the Type 105 Square-Wave Generator, or equivalent through a 10X attenuator, a coaxial cable, a 50-ohm termination and a 1-MΩ X 20pF input time constant standardizer (in that order) to the A input connector. Fig. 5-40 shows the setup required to perform this step.

c. Set the square-wave generator output amplitude so the display is about 5 div in amplitude.

NOTE

In this step and the remaining steps in the calibration procedure, use the Type 3A7 and time-base positioning controls whenever it is necessary to position the display for best viewing.

d. Using Table 5-5 as a guide, start with adjustment C110 (see Fig. 5-41). Fig. 5-42a shows the correct display

that should be obtained Figs. 5-42b and 5-42c show effects obtained when C110 is improperly adjusted.

When performing the adjustments for input B, be sure to apply the signal to input 8 connector, set the B input AC-DC-GND switch to DC and the A input AC-DC-GND switch to GND to display the waveform.

When proceeding with the 10X, 100X and 1000X input attenuator adjustments, remove the 10X attenuator to obtain more signal drive. Use the Type 105 Output Amplitude control to maintain a 5-div amplitude display. Fig. 5-42d, for example, shows a typical display obtained when C206E and C206B in the 10X attenuator are properly adjusted. Figs. 5-42e and 5-42f show two types of distortion obtained when these adjustments are improperly adjusted.

e. Set the Type 105 DC switch to Off. Disconnect the cable, termination and standardizer.

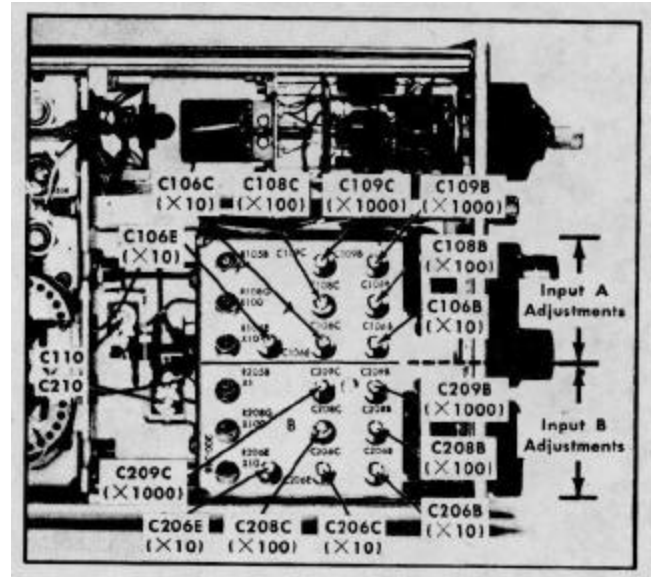

Fig. 5-41. Location of step 34 adjustments.

TABLE 5-5
Compensating the Input Attenuators

Input	INPUT ATTEN Switch Setting	MILLIVOLTS/DIV Switch Setting	Adjust for Optimum	
			Square Corner	Flat Top
A	1	50	No adjustment	C110
B	1	50	No adjustment	C210
B ²	10	50	Adjust C206C first, then C206E ³	C206B
A	10	50	Adjust C106C first, then C106E ³	C106B
A	100	10	C108C	C108B
B	100	10	C208C	C208B
B	1000	1	C209C	C209B
A	1000	1	C109C	C109B

¹For input A, adjust waveform for best upper front corner and flat top. For input B, the waveform is inverted so adjust for best lower front corner and flat bottom. See Fig. 5-41 for adjustment locations and Fig. 5-42 for typical waveforms

²Remove the 10X attenuator to obtain more signal drive.

³If C206E or C106E do not have enough adjustment range, set the adjustment to midrange first and then repeat the procedure given in the table.

Circuit Description-Type 3A7

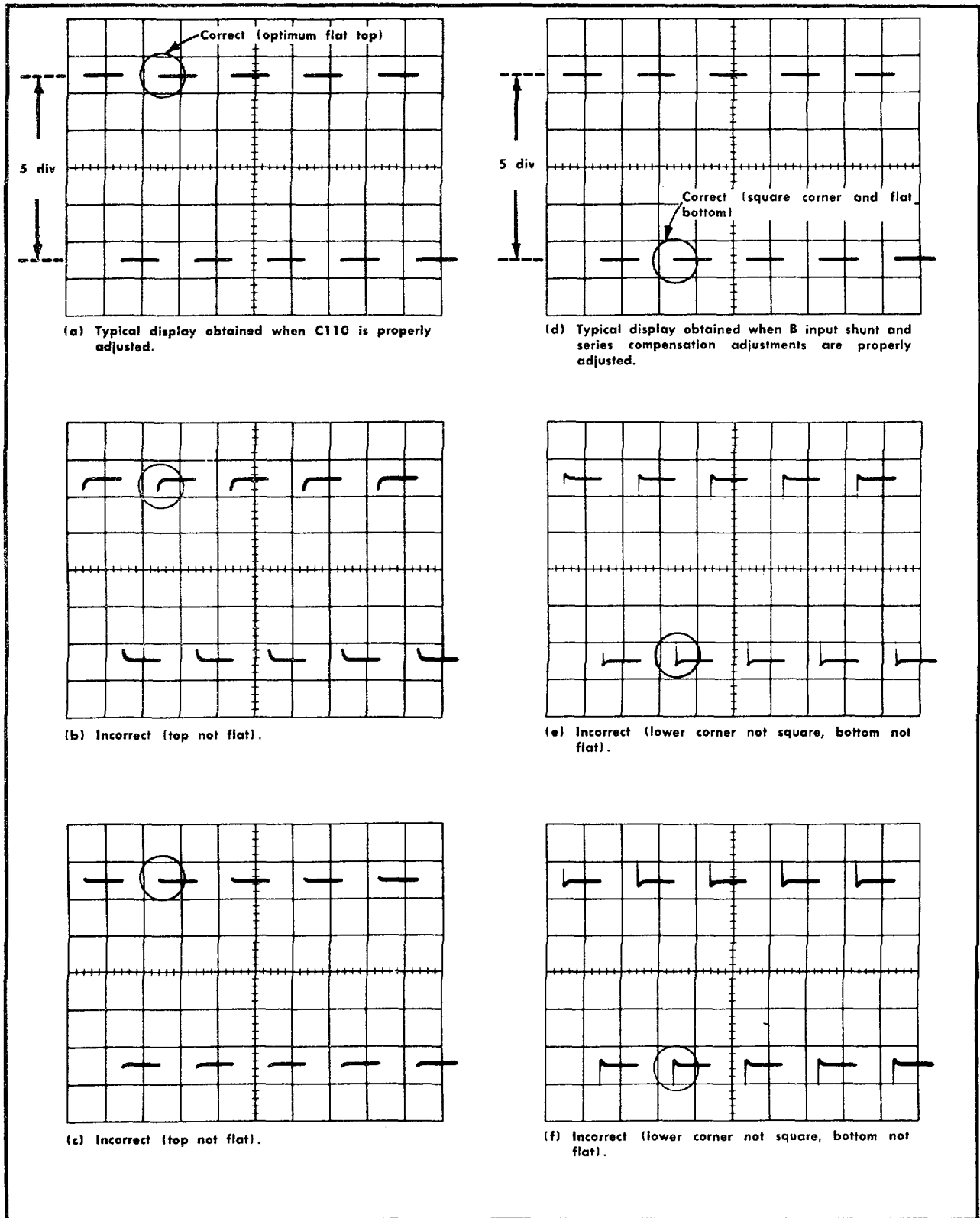

Fig. 5-42. Typical waveform obtained when compensating the attenuators.

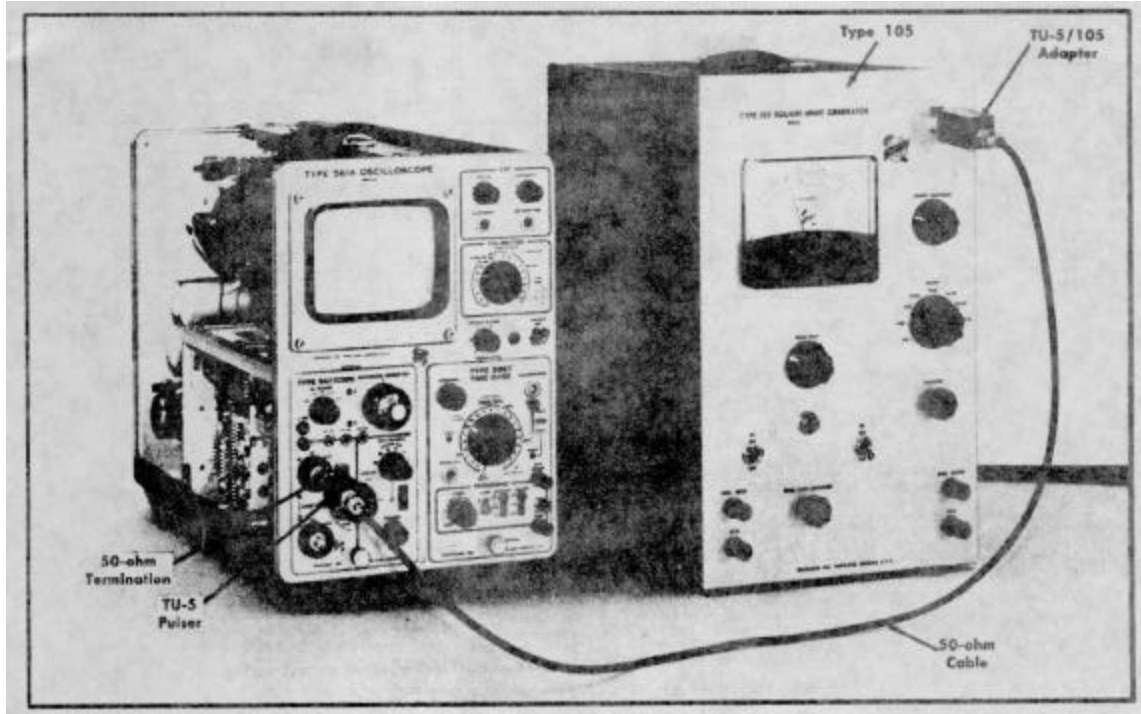

Fig. 5-43. Setup at completion of step 35c.

35. Adjust C255, C281, R280, L170 and L270 (High-Frequency Transient Response)

a. Set the Type 3A7 controls as follows

INPUT ATTEN	1
MILLIVOLTS/DIV	50

b. Set the time-base controls as follows

Time/Div	2 μ Sec
Slope	

Up to this point in the procedure, the remaining controls should be at the following positions:

	Type 3A7	
V _c RANGE	0	
COMPARISON VOLTAGE	As is	
AC-DC-GND (A)	DC	
AC-DC-GND (B)	GND	
DISPLAY	A-B	
VARIABLE POSITION	CAL	Near midrange
	Time Base	
Position	Set so trace starts near left side of graticule	
Variable	Calibrated	

Pull 5X Mag Mode	In
Level	Norm
Coupling	Auto
Source	AC Slow
	Int

c. Starting at the Type 105 Output connector connect the following items in this order: TU-5/105 Adapter, 50-ohm coaxial cable, TU-5 Pulser and 50-ohm termination to the Type 3A7 input A connector. Fig. 5-43 shows the set-up for this step.

d. Set the Type 105 DC switch to On. Set the Type 105 for 100-kHz signal output and set the Output Amplitude control for 100-volts peak-to-peak output into the TU-5/105 adapter.

e. Turn the TU-5 Pulser knob fully counterclockwise. Next, rotate the knob slowly clockwise until the tunnel diode in the pulser triggers; that is, the vertical deflection of the waveform jumps from about 0.5 div to more than 4 div (Fig. 5-44a).

NOTE

The TU-5 Pulser knob should be set only a few degrees clockwise from the triggering point to obtain an optimum square wave from the pulser. If the knob is advanced too far, the leading upper corner on the square-wave display will roll off excessively, resulting in an undesirable waveform.

Circuit Description-Type 3A7

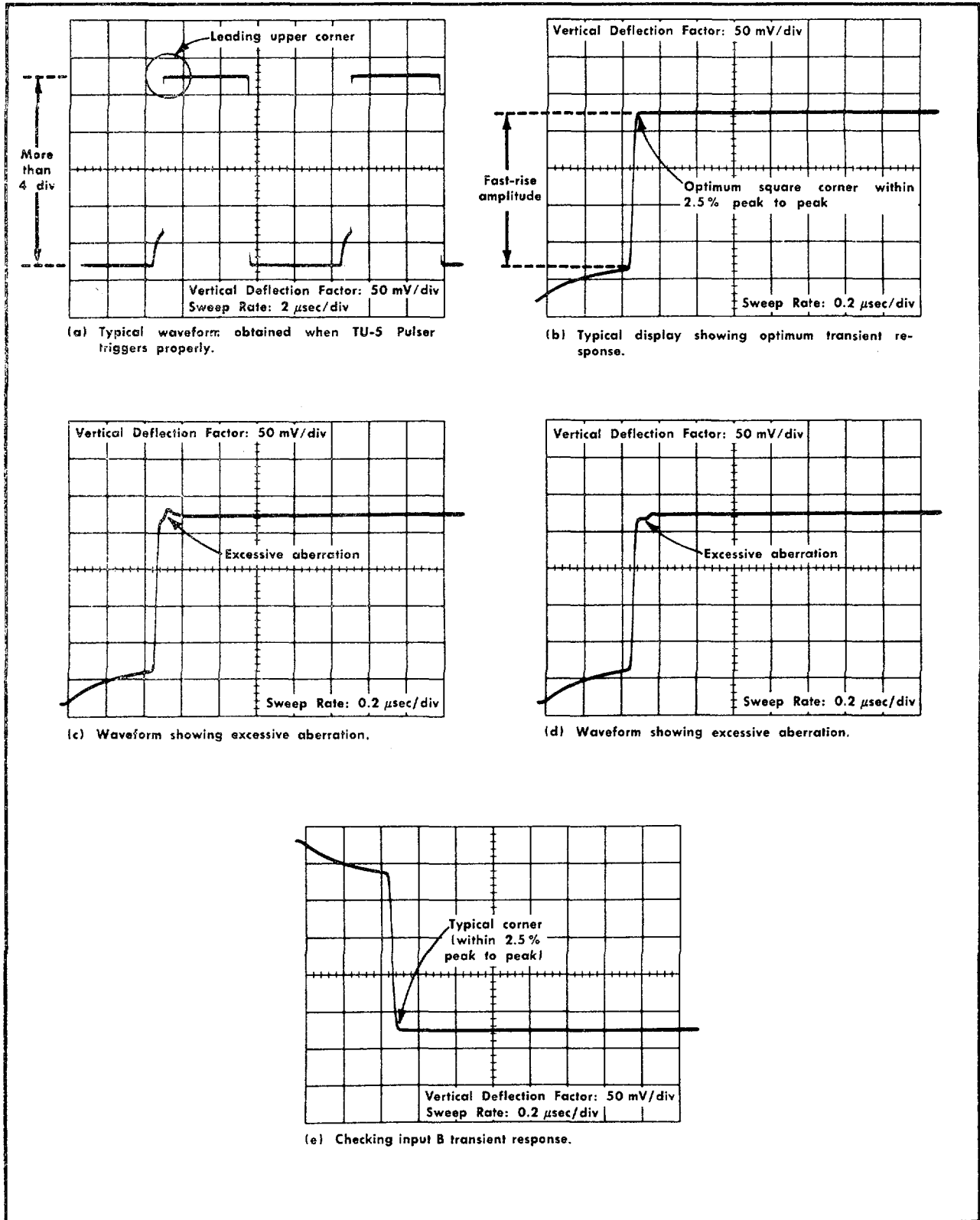

Fig. 5-44. Displays obtained when performing step 35.

f. Set the time-base Time/Div switch to 1 μ Sec and set the Pull 5X Mag switch to its outward position.

g. Examine the leading upper corner of the waveform. Aberrations should not exceed 2.5% peak to peak of the fast-rise amplitude of the waveform. Fig. 5-44b is a typical display that can be used as a guide. If the proper display is obtained, proceed to step 35h. If the display has excessive aberrations such as the examples shown in Figs. 5-44c and 5-44d, adjust C255, C281, R280, L170 and L270 to obtain a display having a fast rise and optimum leading upper square corner. Fig. 5-45 shows the location of the adjustments. Table 5-6 lists the relative time-constant effect that each adjustment has.

TABLE 5-6
Transient Response Adjustments

Adjustment	Relative area on upper front corner affected by the adjustment
C281 and Damping R280	Long time constant from corner to 0.5 div or about 100 ns.
C255	Short time constant; from corner to 0.1 div or about 20 ns.
L170 and L270 ¹	Medium time constant; from corner to 0.3 div or about 60 ns.

¹Adjusted so relative portions of the slugs in the coils are similar, but not necessarily identical.

h. Apply the signal to input B.

i. Set the Type 3A7 controls as follows

AC-DC-GND (A)	GND
AC-DC-GND (B)	DC

j. Set the time-base Triggering Slope switch to +.

k. Check the negative-going square-wave display for a square lower corner. Fig. 5-44e shows a typical display as a guide. If the transient response of the waveform needs to be improved, slightly readjust any of the high-frequency adjustments, as necessary, for best lower corner on the display.

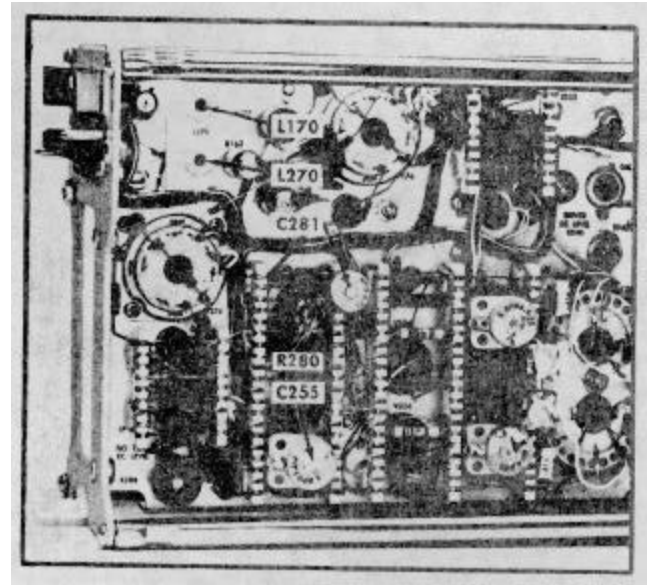

Fig. 5-45. Location of step 35 adjustments.

l. Set the Type 3A7 controls as follows:

AC-DC-GND (A)	DC
AC-DC-GND (B)	GND

m. Set the time-base Triggering Slope switch to -.

n. Apply the signal to input A.

o. Repeat steps 35g through k. Recheck the A and B displays. Front-corner aberrations should not exceed 2.5% of the fast-rise amplitude of the waveform.

p. Disconnect the signal from the Type 3A7 and turn off the square-wave generator.

Circuit Description-Type 3A7

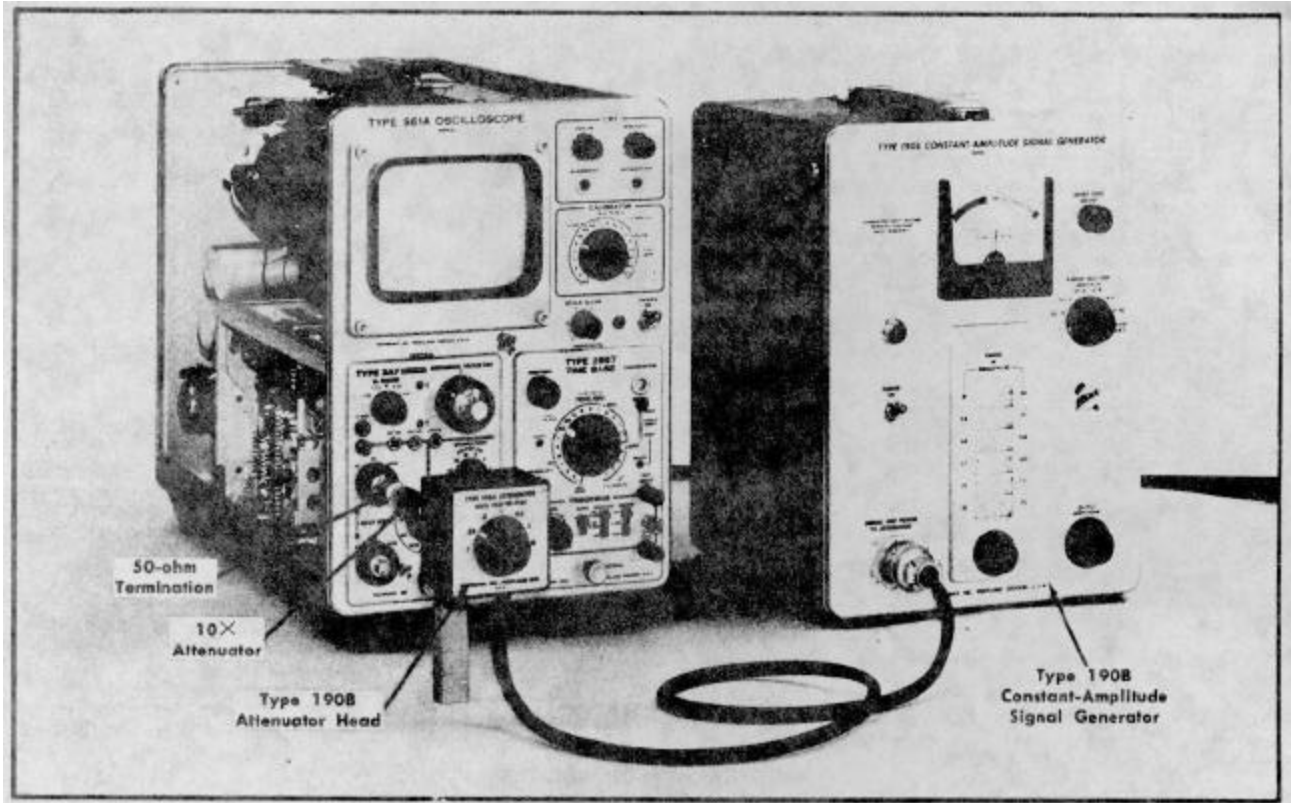

Fig. 5-46. Setup at completion of stop 36c.

36. Check High-Frequency Sine-Wave Response

a. Set the time-base controls as follows:

Time/Div	.5 mSec
Pull 5X Mag	In

b. Set the Type 3A7 controls as follows

AC-DC-GND (A)	DC
AC-DC-GND (B)	GND

Up to this point in the procedure, the controls should be at the following positions:

Type 3A7

Vc RANGE	0
COMPARISON VOLTAGE	As is
DISPLAY	A-B
INPUT ATTEN	1
MILLIVOLTS/DIV	50
VARIABLE POSITION	CAL Near midrange

Time Base

Position	Set so trace starts near left side of graticule
----------	---

Variable Mode	Calibrated Norm
Level	Auto
Slope	+
Coupling	AC Slow
Source	Int

c. Apply a 50-kHz 300-mV peak-to-peak sine-wave reference signal from the Type 190B to the B input connector. Use a 10X attenuator and 50-ohm termination, connected in series, to reduce and terminate the signal output from Type 190B attenuator head. Set the Type 190B attenuator-head switch and front-panel Output Amplitude control so the vertical deflection of the display is exactly 6 div (300 mV). Fig. 5-46 shows the setup. Fig. 5-47a shows the display that should be obtained.

d. Without changing the output amplitude, set the Type 190B for 10-MHz sine-wave output.

e. Check the amplitude of the display. It should be 4.2 div or more in amplitude, which corresponds to the 30% (or less) down requirement (see Fig. 5-47b).

In a similar manner, check the frequency response of the amplifier using the B input Continue with the checks until all MILLIVOLTS/DIV switch positions are checked. Table 5-7, which includes the A input check made at 50 mV/div, is

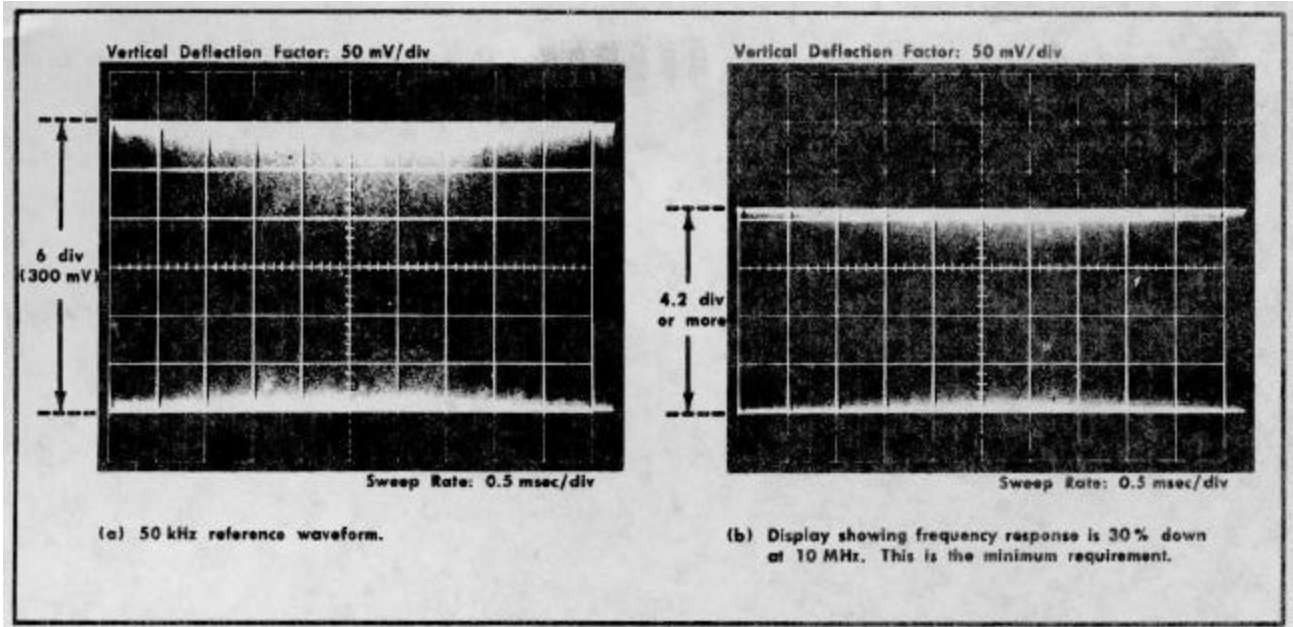

Fig. 5-47. Checking the frequency response of the system.

provided as a guide for checking amplifier frequency response at all the MILLIVOLTS/DIV switch settings. As described earlier, when applying the signal to one connector and then the other alternately, set the AC-DC-GND switches to their appropriate positions.

TABLE 5-7
Checking High-frequency Sine-Wave Response

Input	MILLI-VOLTS/DIV Switch Setting	Frequency Response (Upper end 30%-down point)
A	50	≥ 10 MHz
B	50	
B	20	
A	20	
A	10	≥ 8 MHz
B	10	
B	5	≥ 6 MHz
A	0	
A	2	≥ 4 MHz
B	2	
B	1	
A	1	

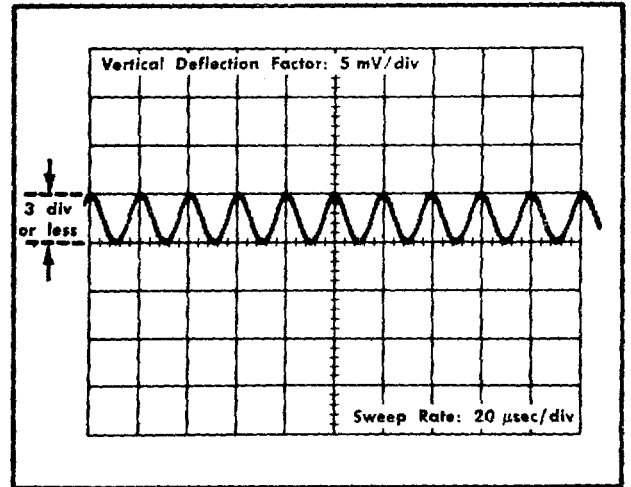

Fig. 5-48. Checking input crosstalk to B side of amplifier when signal is applied to input A.

37. Check Input Crosstalk

- a. Set the MILLIVOLTS/DIV switch to 50.
- b. Set the time-base Time/Div switch to 20 μSec.

c. Set the Type 190B for 300-mV 50-kHz sine-wave output. The display should be the same amplitude as that shown in Fig. 5-47a.

- d. Set the Type 3A7 controls as follows

ACDC-GND (B)	DC
DISPLAY	Vc-B
MILLIVOLTS/DIV	5

Circuit Description-Type 3A7

e. Check that the amplitude of the display is 3 div or less (see Fig. 5-48). This corresponds to the $\leq 5\%$ input crosstalk requirement.

f. Disconnect the signal from the A input connector.

g. Set the DISPLAY switch to A-Vc.

h. Apply the signal to B input connector.

i. Check the amplitude of the display. It should be 3 div or less.

j. Disconnect the signal.

PARTS LIST ABBREVIATIONS

BHB	binding head brass	int	internal
BHS	binding head steel	lg	length or long
cap.	capacitor	met	metal
cer	ceramic	mtg hdw	mounting hardware
comp	composition	OD	outside diameter
conn	connector	OHB	oval head brass
CRT	cathode-ray tube	OHS	oval head steel
csk	countersunk	PHB	pan head brass
DE	double end	PHS	pan head steel
dia	diameter	plstc	plastic
div	division	PMC	paper, metal cased
elect.	electrolytic	poly	polystyrene
EMC	electrolytic, metal cased	prec	precision
EMT	electrolytic, metal tubular	PT	paper, tubular
ext	external	PTM	paper or plastic, tubular, molded
F & I	focus and intensity	RHB	round head brass
FHB	flat head brass	RHS	round head steel
FHS	flat head steel	SE	single end
Fil HB	fillister head brass	SN or S/N	serial number
Fil HS	fillister head steel	SW	switch
h	height or high	TC	temperature compensated
hex.	hexagonal	THB	truss head brass
HHB	hex head brass	thk	thick
HHS	hex head steel	THS	truss head steel
HSB	hex socket brass	tub.	tubular
HSS	hex socket steel	var	variable
ID	inside diameter	w	wide or width
incd	incandescent	WW	wire-wound

PARTS PROVISIONING LIST

REPLACEMENT PARTS

To obtain replacement parts, find the manufacturer's part number and description in this manual and then refer to the appropriate Repair Parts and Special Tools List (RPSTL) TM. In the RPSTL, find the assembly or subassembly first and then the description which corresponds with that in this manual. Under the description in the RPSTL find the manufacturer's part number, and then order the part by the listed Federal Stock Number. If the part is not listed in the RPSTL, it should be requisitioned from the NICP in accordance with AR 725-50.

SPECIAL NOTES AND SYMBOLS

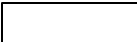
- X000 Part first added at this serial number
- 00X Part removed after this serial number
- *000-0000-00 Asterisk preceding Tektronix Part Number indicates manufactured by or for Tektronix, Inc., or reworked or checked components.
- Use 000-0000-00 Part number indicated is direct replacement.
-  Screwdriver adjustment.
-  Control, adjustment or connector.

SECTION 6 ELECTRICAL PARTS LIST

Values are fixed unless marked Variable.

Ckt. No.	Tektronix Part No.	Description Bulbs	S/N Range
B300	*050-0283-00	Replacement Kit	100-199
B300	150-0030-00	Neon NE-2V	200-up
B302	*050-0283-00	Replacement Kit	100-199
B302	150-0030-00	Neon NE-2V	200-up

Capacitors

Tolerance $\pm 20\%$ unless otherwise indicated.

C101†	*295-0094-00	01 μ F	PTM		600V	+5% -15%	
C103	283-0059-00	1 μ F	Cer		25V	+80% -20%	
C106B	281-0102-00	1.7-11 pF	Air	Var			
C106C	281-0102-00	1.7-11 pF	Air	Var			
C106D	283-0109-00	27 pF	Cer		1000 V	5%	
C106E	281-0098-00	1.2-3.5 pF	Air	Var			
C106F	281-0613-00	10 pF	Cer		200V	10%	
C108B	281-0103-00	1.8-13 pF	Air	Var			
C108C	281-0098-00	1.2-3.5 pF	Air	Var			
C108E	283-0108-00	220 pF	Cer		200 V	10%	
C109B	Use 281-0102-00	1.7-11 pF	Air	Var			
C109C	281-0098-00	1.2-3.5 pF	Air	Var			
C109D	283-0607-00	2000 pF	Mica		500 V	10%	
C110	281-0099-00	1.3-5.4 pF	Air	Var			
C113	281-0077-00	1.3-5.4 pF	Air	Var			
C120	281-0010-00	4.5-25 pF	Cer	Var			
C122	281-0519-00	47 pF	Cer		500 V	10%	
C143	281-0625-00	35 pF	Cer		500 V	5%	
C150A	281-0534-00	3.3 pF	Cer			± 0.25 pF	X510-up
C150B	281-0544-00	5.6 pF	Cer		500 V	10%	
C150C	281-0503-00	8 pF	Cer		500 V	± 0.5 pF	
C155	281-0526-00	1.5 pF	Cer		500 V	± 0.5 pF	100-509
C155	281-0547-00	2.7 pF	Cer		500 V	10%	510-up
C156	281-0613-00	10 pF	Cer		200 V	10%	
C158	283-0103-00	180 pF	Cer		500 V	5%	X460-up
C162	283-0002-00	0.01 μ F	Cer		500 V		
C166	283-0002-00	0.01 μ F	Cer		500 V		
C172	283-0000-00	0.001 μ F	Cer		500 V		
C201†	*295-0094-00	0.1 μ F	PTM		600 V	+5% -15%	
C206B	281-0102-00	1.7-11 pF	Air	Var			
C206C	281-0102-00	1.7-11 pF	Air	Var			
C206D	283-0109-00	27 pF	Cer		1000 V	5%	
C206E	281-0098-00	1.2-3.5 pF	Air	Var			
C206F	281-0613-00	10 pF	Cer		200V	10%	
C208B	281-0103-00	1.8-13 pF	Air	Var			
C208C	281-0098-00	1.2-3.5-pF	Air	Var			
C208E	283-0108-00	220 pF	Cer		200 V	10%	
C209B	281-0103-00	1.8-13 pF	Air	Var			
C209C	281-0098-00	1.2-3.5 pF	Air	Var			
C209D	283-0607-00	2000 pF	Mica		500 V	10%	

†C101 and C201 matched within $\pm 1\%$ of each other, furnished as a unit.

Electrical Parts List - Type 3A7

Capacitors (Cont'd)

Ckt. No.	Tektronix Part No.	Description	S/N Range
C210	281-0099-00	1.3-5.4 pF Air Var	
C213	281-0077-00	1.3-5.4 pF Air Var	
C220	281-0010-00	4.5-25 pF Cer Var	
C222	281-0519-00	47 pF Cer 500 V 10%	
C243	281-0625-00	35 pF Cer 500 V 5%	
C255	281-0005-00	1.5-7 pF Cer Var	
C256	281-0613-00	10 pF Cer 200 V 10%	
C272	283-0000-00	0.001 μF Cer 500 V	
C280	281-0504-00	10 pF Cer Selected 500 V 10%	
C281	281-0075-00	5-25 pF Cer Var	100-569
C281	281-0022-00	8-50 pF Cer Var	570-up
C286	283-0002-00	0.01 μF Cer 500 V	
C292	290-0136-00	2.2 μF EMT 20 V	
C304	283-0001-00	0.005 μF Cer 500 V	
C310	283-0002-00	0.01 μF Cer 500 V	
C314	283-0002-00	0.01 μF Cer 500V	
C318	290-0164-00	1 μF EMT 150 V	
C322	283-0001-00	0.005 μF Cer 500 V	
C330	283-0026-00	0.2 μF Cer 25 V	
C332	283-0002-00	0.01 μF Cer 500 V	

Diodes

D110	*152-0165-00	Silicon	Selected from 1N3579	
D124A, B	*152-0178-00	Silicon	Tek Spec	
D148	*152-0153-00	Silicon	Replaceable by 1N4244	
D150	*152-0153-00	Silicon	Replaceable by 1N4244	
D152	152-0149-00	Zener	1N961B 04 W, 10 V, 5%	X460-up
D168	*152-0185-00	Silicon	Replaceable by 1N4152	
D210	*152-0165-00	Silicon	Selected from 1N3579	
D252	152-0149-00	Zener	1N961B 0.4 W, 10 V, 5%	X460-up
D260	152-0195-00	Zener	1N751A 0.4W, 5.1 V, 5%	X460-up
D261	*152-0185-00	Silicon	Replaceable by 1N4152	X460-up
D262	152-0195-00	Zener	1N751A 0.4 W, 5.1 V, 5%	X460-up
D263	*152-0185-00	Silicon	Replaceable by 1N4152	X460-up
D278	*152-0185-00	Silicon	Replaceable by 1N4152	
D282	*152-0185-00	Silicon	Replaceable by 1N4152	
D286	152-0176-00	Zener	1N980A 0.4 W, 62 V, 10%	100-889
D286	152-0285-00	Zener	1N980B 0.4 W, 62 V, 5%	890-up
D292	152-0008-00	Germanium		
D324	152-0172-00	Zener	1N970A 0.4 W, 24 V, 10%	100-889
D324	152-0265-00	Zener	1N970B 04 W, 24 V, 5%	890-up
D330	152-0166-00	Zener	1N753A 0.4 W, 6.2 V, 5%	
D401	*152-0171-00	Zener	Selected 1N944 11.7 V, 5%	

Instructors

L101	276-0507-00	Core, Ferramic Suppressor	
LR106B	*108-0332-00	075 μH (wound on a 130 Ω resistor)	
LR106G	*108-0270-00	0.25 μH (wound on a 62 Ω resistor)	
LR108B	*108-0298-00	0.25 μH (wound on a 36 Ω resistor)	
LR108D	*108-0271-00	0.25 μH (wound on a 51 Ω resistor)	
L169	*108-0148-00	2.5 μH	
L170	*114-0190-00	50-75 μH Core 276-0511-00 Var	
L201	276-0507-00	Core, Ferramic Suppressor	
LR206B	*108-0332-00	0.75 μH (wound on a 130 Ω resistor)	
LR206G	*108-0270-00	0.25 μH (wound on a 62 Ω resistor)	

Inductors (Cont'd)

Ckt. No.	Tektronix Part No.	Description	S/N Range
LR208B	*108-0298-00	0.25 μ H (wound on a 36 Ω resistor)	
LR208D	*108-0271-00	0.25 μ H (wound on a 51 Ω resistor)	
L269	*108-0148-00	2.5 μ H	
L270	*114-0190-00	50-75 μ H	Core 276-0511-00 Var
L280	*108-0057-00	8.8 μ H	

Connector

P11	131-0149-00	Chassis mounted, 24 contact male
-----	-------------	----------------------------------

Transistors

Q144	*151-0139-00	Selected 2N918's (dual)
Q154	*151-0133-00	Selected from 2N3251
Q164	*151-0108-00	Replaceable by 2N2501
Q174	*151-0103-00	Replaceable by 2N2219
Q234	*151-0103-00	Replaceable by 2N2219
Q254	*151-0133-00	Selected from 2N3251
Q264	*151-0108-00	Replaceable by 2N2501
Q274	*151-0103-00	Replaceable by 2N2219
Q284	*151-0133-00	Selected from 2N3251
Q294	*151-0136-00	Replaceable by 2N3053
Q304	*151-0096-00	Selected from 2N1893

Resistors

Resistors are fixed, composition, 10% \pm unless otherwise indicated.

R103	316-0470-00	47 Ω	1/4 W			
R105A	323-0680-00	988 k	1/2 W		Prec	1%
R105B	311-0487-00	30 k		Var		
R106A†	325-0004-00	900 k	1/4 W		Prec	0.1%
R106C††	325-0003-00	99.8 k	1/8 W		Prec	0.1%
R106E	311-0486-00	500 Ω		Var		
R106F	316-0101-00	100 Ω	1/4 W			
R108A	323-0681-00	990 k	1/2 W		Prec	1/2 %
R108F	321-0637-00	9.9 k	1/8 W		Prec	1/2 %
R108G	311-0485-00	250 Ω		Var		
R109A	323-0623-00	999 k	1/2 W		Prec	1%
R109B	316-0101-00	100 Ω	1/4 W			
R109D	316-0470-00	47 Ω	1/4 W			
R109F	321-0193-00	1 k	1/8 W		Prec	1%
R110	315-0271-00	270 Ω	1/4 W			5%

†Furnished as a unit with R206A (matched pair).

††Furnished as a unit with R206C (matched pair).

Electrical Parts List - Type 3A7

Resistors (Cont'd)

Ckt. No.	Tektronix Part No.		Description			S/N Range
R111	323-0373-00	75 k	1/2 W	Prec	1%	
R114	323-0281-00	8.25 k	1/2 W	Prec	1%	
R120	316-0101-00	100 Ω	1/4 W			
R122	323-0481-00	1 meg	1/2 W	Prec	1%	
R123	323-0373-00	75 k	1/2 W	Prec	1%	
R126	316-0101-00	100 Ω	1/4 W			
R128	323-0327-00	24.9 k	1/2 W	Prec	1%	
R129	321-0215-00	1.69 k	1/8 W	Prec	1%	
R130	311-0566-00	5 k		Var		
R132	321-0215-00	1.69 k	1.8 W	Prec	1%	
R134	323-0289-00	10k	1/2 W	Prec	1%	
R136	323-0277-00	7.5 k	1/2 W	Prec	1%	
R138	321-0389-00	110k	1/8 W	Prec	1%	
R140	323-0293-00	11 k	1/2 W	Prec	1%	
R142	321-0077-00	61.9 Ω	1/8 W	Prec	1%	
R143	316-0562-00	5.6k	1/4 W			
R147	316-0101-00	100 Ω	1/4 W			
R149	323-0210-00	1.5 k	1/2 W	Prec	1%	
R150A	323-0239-00	3.01 k	1/2 W	Prec	1%	
R150B	323-0181-00	750 Ω	1/2 W	Prec	1%	
R150C	323-0147-00	332 Ω	1/2 W	Prec	1%	
R150D	323-0116-00	158 Ω	1/2 W	Prec	1%	
R150E	323-0647-00	61.4 Ω	1/2 W	Prec	1%	
R152	308-0301-00	10k	3W	WW	1%	
R155	323-0203-00	1.27 k	1/2 W	Prec	1%	
R157	323-0227-00	2.26 k	1/2 W	Prec	1%	
R158	315-0471-00	470 Ω	1/4 W		5%	X460-up
R162	308-0383-00	12 k	5 W	WW	5%	
R166	316-0470-00	47 Ω	1/4 W			
R168	323-0291-00	10.5 k	1/2 W	Prec	1%	
R170	*310-0626-00	2k	11W	WW	1%	
R172	302-0104-00	100 k	1/2 W			
R173	323-0303-00	14 k	1/2 W	Prec	1%	
R174	316-0470-00	47 Ω	1/4 W			
R205A	323-0680-00	988 k	1/2 W	Prec	1%	
R205B	311-0487-00	30 k		Var		
R206A†	325-0004-00	900 k	1/4 W	Prec	0.1%	
R206C††	325-0003-00	99.8 k	1/8 W	Prec	0.1%	
R206E	311-0486-00	500 Ω		Var		
R206F	316-0101-00	100 Ω	1/4 W			
R208A	323-0681-00	990 k	1/2 W	Prec	1/2 %	
R208F	321-0637-00	9.9 k	1/8 W	Prec	1/2 %	
R208G	311-0485-00	250 Ω		Var		
R209A	323-0623-00	999 k	1/2 W	Prec	1%	
R209B	316-0101-00	100 Ω	1/4 W			
R209D	316-0470-00	47 Ω	1/4 W			

†Furnished as a unit with R106A (matched pair).

††Furnished as a unit with R106C (matched pair).

Electrical Parts List - Type 3A7

Resistors (Cont'd)

Ckt. No.	Tektronix Part No.		Description			S/N Range
R209F	321-0193-00	1 k	1/8 W		Prec	1%
R210	315-0271-00	270 Ω	1/4 W			5%
R211	323-0373-00	75 k	1/2 W		Prec	1%
R212	311-0497-00	50 k		Var		
R214	323-0281-00	8.25 k	1/2 W		Prec	1%
R216	311-0329-00	50 k		Var		
R220	316-0101-00	100 Ω	1/4 W			
R222	323-0481-00	1 meg	1/2 W		Prec	1%
R223	323-0373-00	75 k	1/2 W		Prec	1%
R226	316-0101-00	100 Ω	1/4 W			
R230	316-0470-00	47 Ω	1/4 W			
R232	323-0242-00	3.24 k	1/2 W		Prec	1%
R233	311-0443-00	2.5 k		Var		
R236	323-0277-00	7.5 k	1/2 W		Prec	1%
R238	321-0389-00	110 k	1/8 W		Prec	1%
R240	323-0293-00	11 k	1/2 W		Prec	1%
R242	321-0077-00	61.9 Ω	1/8 W		Prec	1%
R243	316-0562-00	5.6 k	1/4 W			
R244	311-0482-00	150 Ω		Var		
R245	311-0568-00	600 Ω		Var		
R247	316-0101-00	100 Ω	1/4 W			
R249	323-0210-00	1.5 k	1/2 W		Prec	1%
R252	308-0301-00	10 k	3 W		WW	1%
R253	311-0475-00	5 k		Var	WW	
R255	323-0203-00	1.27 k	1/2 W		Prec	1%
R257	323-0227-00	2.26 k	1/2 W		Prec	1%
R258	311-0091-00	1 k		Var		
R260	311-0474-00	2 k		Var	WW	
R262	321-0076-00	60.4 Ω	1/8 W		Prec	1%
R264	308-0334-00	7 k	3 W		WW	3%
R266	316-0470-00	47 Ω	1/4 W			
R270	*310-0626-00	2 k	11 W		WW	1%
R272	302-0104-00	100 k	1/2 W			
R273	323-0303-00	14k	1/2 W		Prec	1%
R274	316-0470-00	47 Ω	1/4 W			
R276	321-0061-00	42.2 Ω	1/8 W		Prec	1%
R277	308-0107-00	1 k	5W		WW	5%
R278	323-0291-00	10.5 k	1/2 W		Prec	1%
R279	321-0061-00	42.2 Ω	1/8 W		Prec	1%
R280	311-0496-00	2.5 k		Var		
R281	323-0244-00	3.4 k	1/2 W		Prec	1%
R282	301-0563-00	56 k	1/2 W			5%
R284	323-0320-00	21 k	1/2 W		Prec	1%
R288	311-0074-00	5 k		Var		
R289	323-0315-00	18.7 k	1/2 W		Prec	1%

†Furnished as a unit with SW245.

Electrical Parts List - Type 3A7

Resistors (Cont'd)

Ckt. No.	Tektronix Part No.		Description			S/N Range
R290	323-0306-00	15k	1/2 W		Prec	1%
R292	316-0101-00	100 Ω	1/4 W			
R294	303-0333-00	33 k	1 W			5%
R300	302-0563-00	56k	1/2 W			100-199
R300	302-0823-00	82 k	1/2 W			200-up
R302	302-0223-00	22 k	1/2 W			100-99
R302	302-0273-00	27 k	1/2 W			200-up
R304	302-0563-00	56k	1/2 W			
R306	316-0153-00	15k	1/4 W			
R310	316-0223-00	22 k	1/4 W			
R314	308-0271-00	667 Ω	5W		WW	5%
R318	316-0271-00	270 Ω	1/4 W			
R320	308-0319-00	4.5 k	3 W		WW	1%
R322	323-0347-00	40.2 k	1/2 W		Prec	1%
R324	303-0223-00	22 k	1 W			5%
R330	303-0123-00	12k	1 W			5%
R332	316-0220-00	22 Ω	1/4 W			
R336	303-0680-00	68 Ω	1 W			5%
R338	311-0001-00	10 Ω		Var	WW	
R342	304-0102-00	1 k	1 W			
R346	302-0104-00	100 k	1/2 W			
R401	308-0360-00	13.3 k	3 W		WW	1%
R403	308-0359-00	10.35 k	3W		WW	1%
R406	301-0113-00	11 k	1/2 W			5%
R408	Selected					
R410	311-0484-00	500 Ω		Var		
R413	308-0326-00	9.9 k	1/8 W		WW	0.01%
R415	308-0324-00	1.222 k	1/8 W		WW	0.01%
R422	308-0316-00	3.1 k	1/2 W		WW	1%
R423	311-0484-00	500 Ω		Var		
R425	311-0360-00	5 k		Var		
R427	302-0102-00	1 k	1/2 W			
R430	308-0323-00	1k	1/4 W			Matched set of 12 to ± 0.02% grouping.
R431						
R432						
R433						
R434						
R435						
R436						
R436						
R437						
R438						
R439						
R440						
R441						

Electrical Parts List - Type 3A7

Switches

Ckt. No.	Tektronix Part No.		Description	S/N Range
	Unwired	Wired		
SW101 SW105† SW205 }	260-0603-00		Rotary	AC-DC-GND A
	260-0634-00	*262-0680-01	Rotary	INPUT ATTEN
SW110††	260-0635-00	*262-0679-00	Rotary	DISPLAY
SW150	260-0713-00	*262-0734-00	Rotary	MILLIVOLTS/DIV
SW150	260-0713-00	*262-0734-01	Rotary	MILLIVOLTS/DIV
SW201	260-0603-00		Rotary	ACDC-GND B
SW245†††	311-0568-00			
SW410	260-0633-00	*262-0733-00	Rotary	Vc RANGE
SW420	260-0712-00	*262-0732-00	Rotary	COMPARISON VOLTAGE (Vc)

Test Points

TP264	344-0105-00	Clip, test point
TP294	344-0105-00	Clip, test point
TP420	129-0006-00	Post, connecting

Electron Tubes

V113††††	*157-0099-00	8056, checked
V124	154-0187-00	6DJ8
V134	154-0187-00	6DJ8
V174	154-0491-00	8608
V213††††	*157-0099-00	8056, checked
V224	154-0187-00	6DJB
V274	154-0491-00	8608

- † SW105 and SW205 furnished as a unit.
- †† SW110 concentric with SW105 and SW205.
- ††† SW245 furnished as a unit with R245.
- †††† V113 and V213 furnished as a pair.

SECTION 7
MECHANICAL PARTS LIST

A list of abbreviations and symbols used in this section will be found on page 6-0.1.
Parts ordering information is located on page 6-0.2.

Mechanical Parts List - Type 3A7

FRONT & SWITCHES

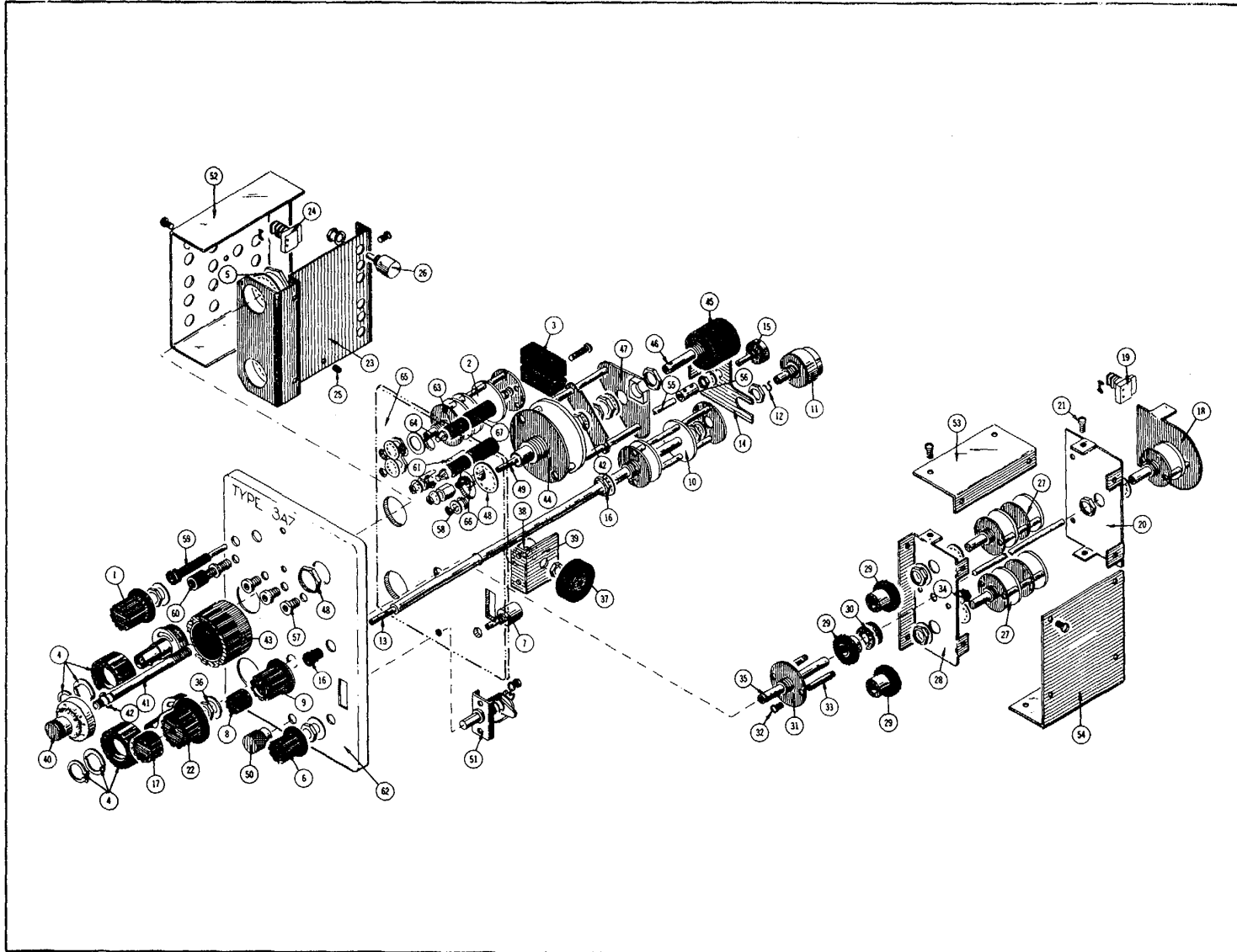

Mechanical Parts List - Type 3A7

FRONT & SWITCHES

REF. NO.	PART NO.	SERIAL/MODEL NO.		QTY.	DESCRIPTION
		EFF.	DISC.		
1	366-0173-00			1	KNOB, charcoal - Vc RANGE
	-----			-	knob includes:
	213-0004-00			1	SCREW, set, 6-32 x 3/16 inch, HSS
2	262-0733-00			1	SWITCH, wired - Vc RANGE
	-----			-	switch includes:
	260-0633-00	1		1	SWITCH, unwired - Vc RANGE
3	-----			2	POT
	-----			-	mounting hardware for each: (not included w/pot)
	211-0034-00	100	349	2	SCREW, 2-56 x 1/2 inch, RHS
	211-0089-00	350		2	SCREW, 2-56 x 3/8 inch, RHS
	210-0001-00			2	LOCKWASHER, internal #2
	210-0405-00			2	NUT, hex., 2-56 x 3/16 inch
	-----			-	mounting hardware: (not included w/switch)
	210-0012-00			1	LOCKWASHER, internal, 3/8 x 1/2 inch
	210-0840-00			1	WASHER, .390 ID x 9/16 inch OD
	210-0413-00			1	NUT, hex., 3/8-32 x 1/2 inch
4	260-0603-00			2	SWITCH, unwired - AC-DC-GND
	-----			-	each switch includes:
	210-0951-00			1	WASHER, locating
	214-0240-00			1	SPRING, compression (not shown)
	214-0274-00			1	BALL, 1/8 inch diameter
	354-0179-00			1	RING, retaining
	366-0274-00			1	KNOB, charcoal - AC-DC-GND
5	-----			-	mounting hardware for each: (not included w/switch)
	210-0047-00			1	LOCKWASHER, internal, 1.110 OD x .880 inch ID
	210-0568-00			1	NUT, mounting, 7/8-32 x 1 1/8 inches
6	366-0225-00			1	KNOB, charcoal - POSITION
	-----			-	knob includes
	213-0020-00			1	SCREW, set, 6-32 x 1/8 inch, HSS
7	-----			1	POT
	-----			-	mounting hardware: (not included w/pot)
	210-0940-00			1	WASHER, 1/4 ID x 3/8 inch OD
	210-0583-00			1	NUT, hex., 1/4-32 x 5/16 inch
8	366-0189-00			1	KNOB, red - VARIABLE CAL
	-----			-	knob includes
	213-0020-00			1	SCREW, set, 6-32 x 1/8 inch, HSS
9	366-0175-00			1	KNOB, charcoal-MILLIVOLTS/DIV
	-----			-	knob includes
	213-0004-00			1	SCREW, set, 6-32 x 3/16 inch, HSS
10	262-0734-00	100	509	1	SWITCH, wired - MILLIVOLTS/DIV
	262-0734-01	510		1	SWITCH, wired-MILLIVOLTS/DIV
	-----			-	switch includes
	260-0713-00			1	SWITCH, unwired-MILLIVOLTS/DIV
11	-----			1	POT
	-----			-	mounting hardware: (not included w/ pot)
	210-0012-00			1	LOCKWASHER, internal, 3/8 x 1/2 inch
	210-0413-00			2	NUT, hex., 3/8-32 x 1/2 inch

Mechanical Parts List - Type 3A7

FRONT & SWITCHES (Cont'd)

REF. NO.	PART NO.	SERIAL/MODEL NO.		QTY.	DESCRIPTION
		EFF.	DISC.		
12	376-0014-00			1	COUPLING, wire
13	384-0365-00			1	SHAFT, inter switch, 1/8 diameter x 8.282 inches long
14	407-0164-00			1	BRACKET, pot
15	-----			1	POT
	-----			-	mounting hardware: (not included w/pot alone)
	210-0940-00			1	WASHER, flat, 1/4 ID x 3/8 inch OD
	210-0583-00			1	NUT, hex., 1/4-32 x 5/16 inch
16	-----			-	mounting hardware: (not included w/switch)
	210-0413-00			1	NUT, hex., 3/8-32 x 1/2 inch
	210-0012-00			1	LOCKWASHER, internal, 3/8 x 1/2 inch
	211-0008-00			2	SCREW, 4-40 x 1/4 inch, PHS
	358-0216-00			1	BUSHING, front panel
17	366-0031-00			1	KNOB, red - DISPLAY
	-----			-	knob includes:
	213-0004-00			1	SCREW, set, 6-32 x 3/16 inch, HSS
18	262-0679-00			1	SWITCH, wired - DISPLAY
	-----			-	switch includes:
	26-0635-00			1	SWITCH, unwired - DISPLAY
	-----			-	mounting hardware (not included w/switch alone)
	210-0012-00			1	LOCKWASHER, internal, 3/8 x 1/2 inch
	210-0413-00			1	NUT, hex., 3/8-32 x 1/2 inch
19	-----			2	CAPACITOR
	-----			-	mounting hardware for each: (not included w/capacitor alone)
	214-0456-00			1	FASTENER, delrin
20	337-0670-00			1	SHIELD, switch mounting
	-----			-	mounting hardware: (not included w/switch)
21	211-0007-00			2	SCREW, 4-40 x 3/16 inch, PHS
22	366-0142-00			1	KNOB, charcoal - INPUT ATTEN
	-----			-	knob includes:
	213-0004-00			1	SCREW, set, 6-32 x 3/16 inch, HSS
	644-0009-01			1	ASSEMBLY, attenuator (see ref #36)
	-----			-	attenuator assembly includes:
	610-0130-00			1	ASSEMBLY, attenuator chassis
	-----			-	assembly includes:
23	441-0586-00			1	CHASSIS, attenuator
	-----			-	mounting hardware (not included w/chassis alone)
	211-0007-00			2	SCREW, 4-40 x 3/16 inch, PHS
24	-----			14	CAPACITOR
	-----			-	mounting hardware for each: not included w/capacitor alone)
	214-0456-00			1	FASTENER, delrin
25	358-136-00			10	BUSHING, teflon

Mechanical Parts List - Type 3A7

FRONT & SWITCHES (Cont'd)

REF. NO.	PART NO.	SERIAL/MODEL NO.		QTY.	DESCRIPTION
		EFF.	DISC.		
26	-----			6	POT
	-----			-	mounting hardware for each: (no included w/pot alone)
	210-0046-00			1	LOCKWASHER, internal, .400 OD x .261 inch ID
	210-0940-00			1	WASHER, 1/4 ID x 3/8 inch OD
	210-0583-00			1	NUT hex., 1/4-32x 5/16 inch
27	262-0680-01			1	SWITCH, wired - INPUT ATTEN
	-----			-	switch includes:
	260-0634-00			2	SWITCH, unwired - INPUT ATTEN
28	-----			-	mounting hardware for each: (not included w/switch alone)
	210-0413-00			1	NUT, hex., 3/8-32 x 1/2 inch
29	337-0671-00			1	SHIELD, switch mounting
30	214-0461-00			3	ASSEMBLY, Gear
	-----			-	each assembly includes:
31	213-0020-00			1	SCREW, set, 6-32 x 1/8 inch, HSS
	210-0913-00			2	WASHER, phenolic, 1/4 ID x 5/8 inch OD
32	387-0985-00			1	PLATE, switch, front
	-----			-	mounting hardware: [not included w/plate alone]
33	211-0019-00			2	SCREW, 4-40 x 1 inch, RHS
34	166-0106-00			2	TUBE, spacing
	210-0586-00			2	NUT, keps, 4-40 x 1/4 inch
35	384-0325-00			1	ROD, shaft drive gear
	-----			-	rod includes:
36	354-0219-00			1	RING, retaining
	-----			-	mounting hardware: (not included w/attenuator assembly)
	210-0840-00			1	WASHER, .390 ID x 9/16 inch OD
37	210-0413-00			1	NUT, hex., 3/8-32 x 1/2 inch
	366-0341-00			1	KNOB, charcoal - DC BAL
38	-----			-	knob includes:
	213-0076-00			1	SCREW, set, 2-56 x 1/8 inch, HSS
39	-----			1	POT
	210-0583-00			-	mounting hardware: (not included w/pot)
40	407-0163-00			1	NUT, hex., 1/4-32 x 5/16 inch
	-----			-	BRACKET, pot
41	210-0586-00			1	mounting hardware: (not included w/ bracket)
	331-0152-00			1	NUT, keps, 4-40 x 1/4 inch
42	-----			-	DIAL, w/o brake
	213-0022-00			-	dial includes:
43	384-0362-00			1	SCREW, set, 4-40 x 3/16 inch, HSS
	-----			1	SHAFT, dial index
44	-----			-	mounting hardware: (not included w/ shaft)
	210-0465-00			2	NUT hex, 1/4-32 x 3/8 inch
	210-0046-00			1	LOCKWASHER, internal, .400 OD x .261 inch ID
	354-0184-00			1	RING, retaining

Mechanical Parts List - Type 3A7

FRONT & SWITCHES (Cont'd)

REF. NOF.	PART NO.	SERIAL/MODEL NO.		QTY.	DESCRIPTION
		EFF.	DISC.		
43	366-0324-00			1	KNOB, charcoal - COMPARISON VOLTAGE (Vc)
	-----			-	knob includes:
	213-0022-00			1	SCREW, set, 4-40 x 3/16 inch, HSS
44	262-0732-00			1	SWITCH, wired-COMPARISON VOLTAGE (Vc]
	-----			-	switch includes:
	260-0712-00			1	SWITCH, unwired
45	-----			1	POT
	-----			-	mounting hardware: (not included)
	210-0012-00			1	LOCKWASHER, internal, 3/8 x 1/2 inch
	210-0413-00	100	789	2	NUT, hex., 3/8-32 x 1/2 inch
	210-0004-00	790		2	LOCKWASHER, internal, #4 (not shown)
	210-0586-00	790		2	NUT, keps, 4-40 x 1/4 inch (not shown)
	211-0097-00	790		2	SCREW, 4-40 x 5/16 inch
	426-0289-00	790		1	MOUNT, plastic
46	213-0075-00			2	SCREW, set, 4-40 x 3/32 inch
47	337-0761-00	100	789	1	SHIELD, switch mounting
	337-0761-01	790		1	SHIELD, switch mounting
	-----			-	shield includes:
	211-0094-00			1	SCREW, 4-40 x 1/2 inch, socket, THS
	-----			-	mounting hardware: (not included w/shield alone)
	210-0017-00			2	LOCKWASHER, #5
	210-0449-00			2	NUT, hex., brass, 5-40 x 1/4 inch
48	-----			-	mounting hardware: (not included w/switch)
	210-0049-00			1	LOCKWASHER, internal, 5/8 inch ID
	210-0579-00			1	NUT, hex., 5/8-24 x 3/4 inch
49	384-0364-00			1	SHAFT, dial index
50	366-0109-00			1	KNOB, aluminum, plug-in securing
	-----			-	knob includes:
	213-0005-00			1	SCREW, set, 8-32 x 1/8 inch, HSS
51	214-0052-00			1	FASTENER, pawl right
	-----			-	mounting hardware: (not included w/fastener)
	210-0004-00			2	LOCKWASHER, internal #4
	210-0406-00			2	NUT, hex, 4-40 x 3/16 inch
52	200-0588-00			1	COVER, attenuator
	-----			-	mounting hardware: (not included w/cover)
	211-0007-00			3	SCREW, 4-40 x 3/16 inch, PHS
	210-0801-00			3	WASHER; 5S x 9/16 inch
53	200-0593-00			1	COVER, attenuator
	-----			-	mounting hardware: (not included w/ cover)
	211-0008-00			4	SCREW, 4-40 x 1/4 inch, PHS
	210-0801-00			3	WASHER, 5S x 9/16 inch
	210-0202-00	X200		1	LUG, solder, SE #6
54	200-0589-00			1	COVER, attenuator
	-----			-	mounting hardware: (not included w/cover)
	211-0008-00			4	SCREW, 4-40 x 1/4 inch, PHS
	210-0801-00			4	WASHER, 5S x 9/16 inch
55	384-0361-00			1	ROD, pot, 1/8 diameter x 7.250 inches long

Mechanical Parts List - Type 3A7

FRONT & SWITCHES (Cont'd)

REF. NO.	PART NO.	SERIAL/MODEL NO.		QTY.	DESCRIPTION
		EFF.	DISC.		
56	376-0029-00	100	689	1	COUPLING, shaft
	-----			-	coupling includes:
	213-0075-00	100	689	1	SCREW, set, 4-40 x 3/32 inch
	376-0051-00	670		1	COUPLING, flexible
	-----			-	coupling includes:
	213-0048-00	670		4	SCREW, set 4-40 x 3/16 inch, HSS
	354-0251-00	670		2	RING, coupling
	376-0048-00	670		1	COUPLING, plastic
57	358-0054-00			1	BUSHING, banana jack
	-----			-	mounting hardware: (not included w/ bushing)
58	210-0046-00			1	LOCKWASHER, internal, .400 OD x .261 inch ID
	210-0465-00			1	NUT hex, 1/4-32 x 3/8 inch
	348-0031-00			1	GROMMET, polypropylene, snap-in, 1/4 inch diameter
59	136-0163-00	100	569	1	SOCKET, tip jack, charcoal
	136-0098-00	570		1	SOCKET, tip jack, black
	-----			-	mounting hardware: (not included w/ socket)
	210-0046-00			1	LOCKWASHER, internal, .400 OD x .261 inch ID
60	129-0053-00			1	ASSEMBLY, binding post
	-----			-	assembly includes:
	200-0103-00			1	CAP
	355-0507-00			1	STEM, adapter
	-----			-	mounting hardware: (not included w/assembly)
	210-0046-00			1	LOCKWASHER, internal, .400 OD x .261 inch ID
	210-0455-00			1	NUT, hex., 1/4-28 x 3/8 inch
61	-----			1	POT
	-----			-	mounting hardware: (not included w/ pot)
	220-0441-00			1	NUT, hex., 1/4-32 x 31/32 inch
	210-0046-00			1	LOCKWASHER, internal, .400 OD x .261 inch ID
	358-0054-00			1	BUSHING, banana jack
62	333-0910-00			1	PANEL, front
63	352-0084-00			2	HOLDER, neon
64	378-0541-00			1	FILTER, lens
65	386-0215-00			1	PLATE, sub-panel, front
66	-----			1	POT
	-----			-	mounting hardware: (not included w/pot)
	220-0440-00			1	NUT, hex., 1/4-32 x 31/32 inch
	210-0046-00			1	LOCKWASHER, internal, .400 OD x .261 inch ID
	358-0054-00			1	BUSHING, banana jack
67	200-0643-00			2	CAP, lamp holder, neon

Mechanical Parts List - Type 3A7

CHASSIS & FRAME

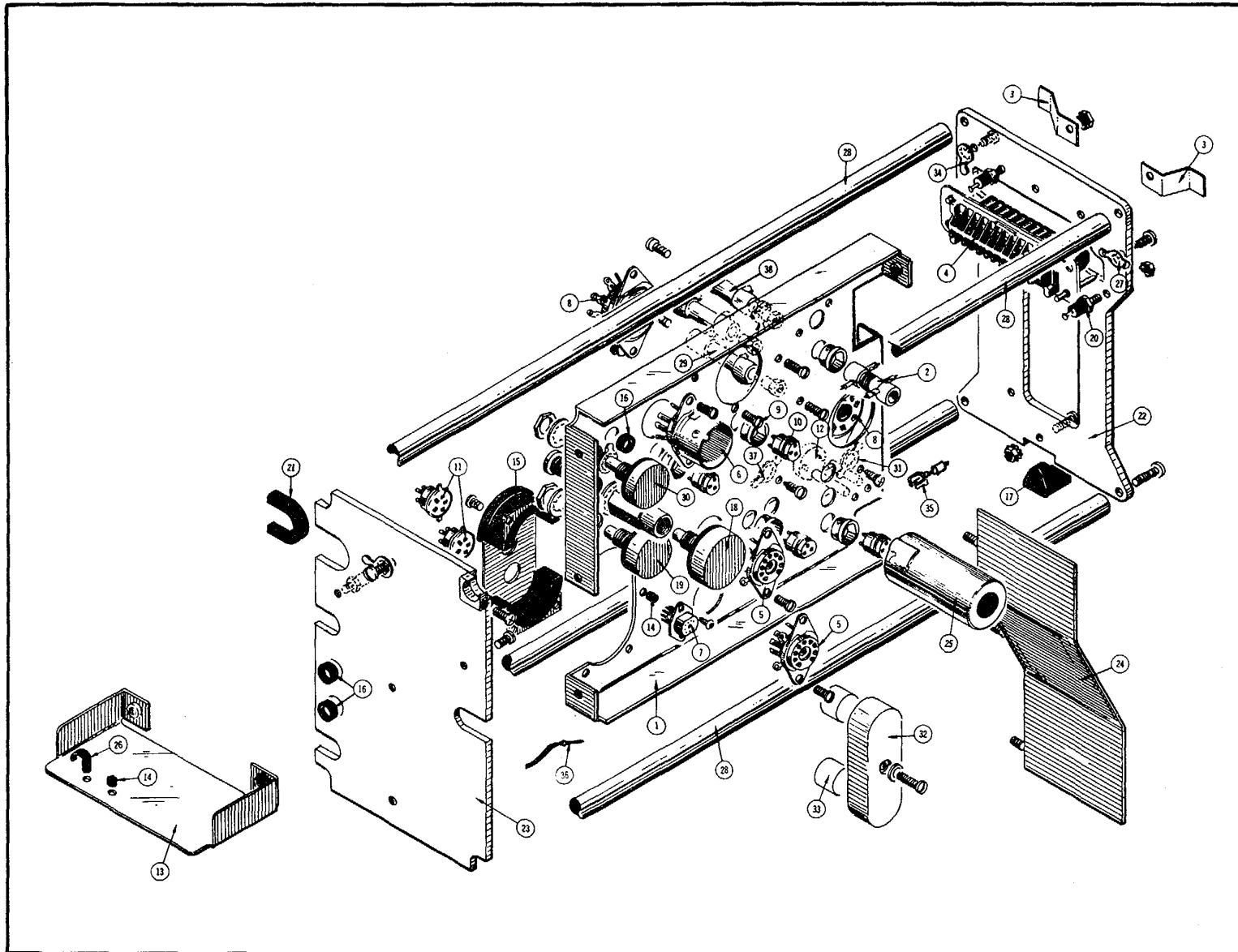

Mechanical Parts List - Type 3A7

CHASSIS & FRAME

REF. NO.	PART NO.	SERIAL/MODEL NO.		QTY.	DESCRIPTION
		EFF.	DISC.		
1	441-0634-00			1	CHASSIS
	-----			-	mounting hardware: (not included w/chassis)
	211-0504-00 210-0202-00			6 1	SCREW, 6-32 x 1/4 inch, PHS LUG, solder, SE #6 w/2 wire holes
2	-----			2	COIL
	354-0234-00			- 1	mounting hardware for each: (not included w/coil) RING, locking, transistor socket
3	214-0276-00			2	SPRING, ground
	-----			-	mounting hardware for each: (not included w/spring)
	129-0006-00 210-0457-00			1 1	POST, connecting, insulated NUT, keps, 6-32 x 5/6 inch
4	131-0149-00			1	CONNECTOR, chassis mounted, 24 contact male
	-----			-	mounting hardware: (not included w/ connector)
	211-0008-00 210-0586-00			2 2	SCREW, 4-40 x 1/4 inch, PHS NUT, keps, 4-40 x 1/4 inch
5	136-0014-00			2	SOCKET, STM9
	-----			-	mounting hardware for each: (not included w/socket)
6	213-0044-00			2	SCREW, thread cutting, 5-32 x 3/16 inch, PHS
	136-0022-00			1	SOCKET, STM9S
7	-----			-	mounting hardware: (not included w/socket)
	213-0044-00			2	SCREW, thread cutting, 5-32 x 3/16 inch, PHS
8	136-0078-00			1	SOCKET, 8 pin miniature
	-----			-	mounting hardware: (not included w/socket)
9	213-0055-00			2	SCREW, thread cutting, 2-56 x 3/16 inch, RHS
	136-0174-00			2	SOCKET, 9 pin
10	-----			-	mounting hardware for each: (not included w/socket)
	213-0044-00			2	SCREW, thread cutting, 5-32 x 3/16 inch, PHS
11	136-0181-00			9	SOCKET, 3 pin transistor
	-----			-	mounting hardware for each: (not included w/socket)
	354-0234-00			1	RING, locking, transistor socket
12	214-0948-00	X570		2	HEAT SINK (not shown)
	136-0188-00			2	SOCKET, 5 pin
12	-----			1	POT
	214-0321-00			- 2	mounting hardware (not included w/pot) FASTENER, mounting, pot

Mechanical Parts List - Type 3A7

CHASSIS & FRAME (Cont'd)

REF. NO.	PART NO.	SERIAL/MODEL NO.		QTY.	DESCRIPTION
		EFF.	DISC.		
13	337-0759-00			1	SHIELD
	-----			-	mounting hardware: (not Included w/ shield)
	129-0006-00			1	POST, connecting, insulated
	211-0504-00			1	SCREW, 6-32 x 1/4 inch, PHS
	210-0457-00			1	NUT, keps, 6-32 x 5/16 inch
14	348-0031-00			6	GROMMET, polypropylene, snap-in, 1/4 inch diameter
15	348-0086-00			1	MOUNT, resilient
	-----			-	mounting hardware (not included w/ mount)
	213-0044-00			4	SCREW, thread cutting, 5-32 x 3/16 inch, PHS, phillips
16	348-0056-00			3	GROMMET, delrin
17	351-0037-00			1	GUIDE, plug-in, delrin
	-----			-	mounting hardware: (not included w/ guide)
	211-0013-00			1	SCREW, 4-40 x 3/8 inch, RHS
	210-0586-00			1	NUT, keps, 4-40 x 1/4 inch
18	-----			1	POT
	-----			-	mounting hardware: (not included w/ pot)
	210-0429-00			1	NUT, hex., bushing, 3/8-32 x 1/2 x 1 1/16 inches
	210-0013-00			1	LOCKWASHER, internal, 3/8 x 11/16 inch
	358-0010-00			1	BUSHING, 3/8-32 x 9/16 inch
19	-----			1	POT
	-----			-	mounting hardware: (not included w/pot)
	210-0840-00			1	WASHER, .390 ID x 9/16 inch OD
	210-0413-00			1	NUT, hex., 3/8-32 x 1/2 inch
20	129-0006-00			1	POST, connecting, insulated
	-----			-	mounting hardware: (not included w/post)
	210-0457-00			1	NUT, keps, 6-32 x 5/16 inch
21	358-0215-00			1	BUSHING, plastic, black
22	386-0214-00			1	PLATE, rear
23	386-0216-00			1	PLATE, bulkhead
	-----			-	Includes:
	211-0094-00			4	SCREW, 4-40 x 1/2 inch, socket, THS, phillips
	337-0788-00			1	SHIELD, chassis mount
24	-----			-	mounting hardware: (not included w/shield)
	210-0586-00			3	NUT, keps, 4-40 x 1/4 inch
25	337-0008-00			1	SHIELD, tube, w/ spring, 1 15/16 inches high
26	343-0089-00			1	CLAMP, cable size (D)
27	210-0204-00			1	LUG, solder, DE #6
	-----			-	mounting hardware: (not included w/ lug)
	211-0504-00			1	SCREW, 6-32 x 1/4 inch, PHS, phillips
	210-0407-00			1	NUT, hex., 6-32 x 1/4 inch

Mechanical Parts List - Type 3A7

CHASSIS & FRAME (Cont'd)

REF. NO.	PART NO.	SERIAL/MODEL NO.		QTY.	DESCRIPTION
		EFF.	DISC.		
28	384-0615-00			4	ROD, spacer, plug-in
	----- 212-0044-00			- 1	mounting hardware for each: (not included w/ rod) SCREW, 8-32 x 1/2 inch, RHS, phillips
29	----- ----- 211-0544-00			2 - 1	RESISTOR mounting hardware for each: (not included w/resistor) SCREW, 6-32 x 3/4 inch, THS, phillips
	210-0478-00			1	NUT, hex., resistor mounting
	211-0507-00			1	SCREW, 6-32 x 5/16 inch, PHS
	----- ----- 210-0207-00			1 - 1	POT mounting hardware: (not included w/ pot) LUG, solder, pot, plain, 3/8 inch
30	210-0012-00			1	LOCKWASHER, internal, 3/8 x 1/2 inch
	210-0840-00			1	WASHER, .390 ID x inch OD
	210-0413-00			1	NUT, hex., 3/8-32 x 1/2 inch
	----- ----- 210-0204-00			1 - 1	LUG, solder, DE #6 mounting hardware: (not included w/ lug) SCREW, thread cutting, 5-32 x 3/16 inch, PHS, phillips
31	213-0044-00			1	SCREW, thread cutting, 5-32 x 3/16 inch, PHS, phillips
	----- ----- 200-0554-00			1 - 1	COVER, heat stabilizer mounting hardware: (not included w/cover) WASHER, 9/64 ID x 5/16 inch OD
32	211-0516-00			1	SCREW, 6-32 x 7/8 inch, PHS, phillips
	----- ----- 377-0103-00			2	INSERT, heat stabilizer
33	210-0202-00			1	LUG, solder, SE #6 w/ 2 wire holes
	----- ----- 211-0504-00			- 1	mounting hardware: (not included w/ lug) SCREW, 6-32 x 1/4 inch, PHS
	210-0407-00			1	NUT, hex., 6-32 x 1/4 inch
34	----- ----- 200-0642-00			2	CAP, plate, tube
	131-0374-00			12	CONNECTOR, male, contact
	210-0201-00			6	LUG, solder, SE #4
35	----- ----- 213-0044-00			- 1	mounting hardware for each: (not included w/ lug) SCREW, thread cutting, 5-32 x 3/16 inch, PHS, phillips
	----- ----- 211-0544-00			1 - 1	RESISTOR mounting hardware: (not included w/ resistor) SCREW, 6-32 x 3/4 inch, THS, phillips
36	210-0478-00			1	NUT, hex., resistor mounting
	210-0202-00			1	LUG, solder, SE #6
	211-0507-00			1	SCREW, 6-32 x 5/16 inch, PHS
	----- ----- 70-0477-00			2	MANUAL, instruction (not shown)
--					ACCESSORIES

Mechanical Parts List - Type 3A7

CABLE HARNESS & CERAMIC STRIPS

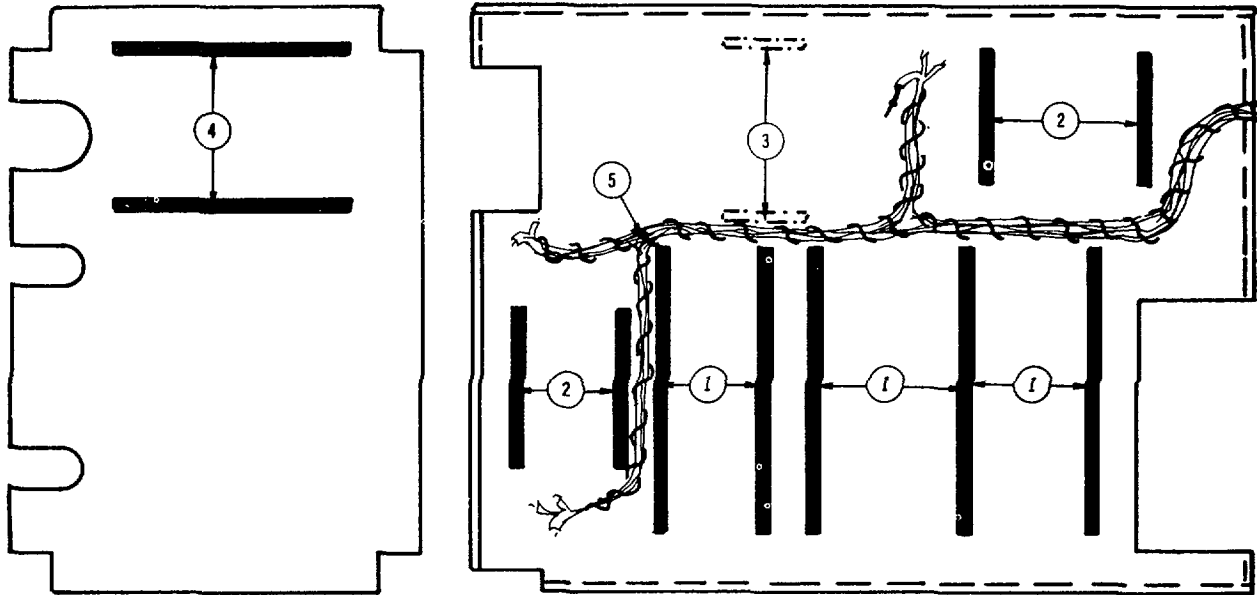

REF. NO.	PART NO.	SERIAL/MODEL NO.		QTY.	DESCRIPTION
		EFF.	DISC.		
1	124-0145-00			5	STRIP, ceramic, 20 notches, 7/16 x 3 inches long
	-----			-	each strip includes:
	355-0046-00			2	STUD, nylon
	-----			-	mounting hardware for each: (not included w/strip)
	361-0009-00			2	SPACER, nylon
2	124-0148-00			4	STRIP, ceramic, 9 notches, 7/16 x 1 7/16 inch
	-----			-	each strip includes:
	355-0046-00			2	STUD, nylon
	-----			-	mounting hardware for each: (not included w/ strip)
	361-0009-00			2	SPACER, nylon
3	124-0087-00			2	STRIP, ceramic, 3 notches x 3/4 inch
	-----			-	each strip includes:
	355-0046-00			1	STUD, nylon
	-----			-	mounting hardware for each: (not included w/ strip)
	361-0009-00			1	SPACER, nylon
4	124-0147-00			2	STRIP, ceramic, 13 notches, 7/16 x 2 inches
	-----			-	each strip includes:
	355-0046-00			2	STUD, nylon
	-----			-	mounting hardware for each: (not included w/ strip)
	361-0009-00			2	SPACER, nylon
5	179-1000-00			1	CABLE HARNESS
	-----			-	cable harness includes
	131-0374000			3	CONNECTOR, male, contact

SECTION 8

DIAGRAMS

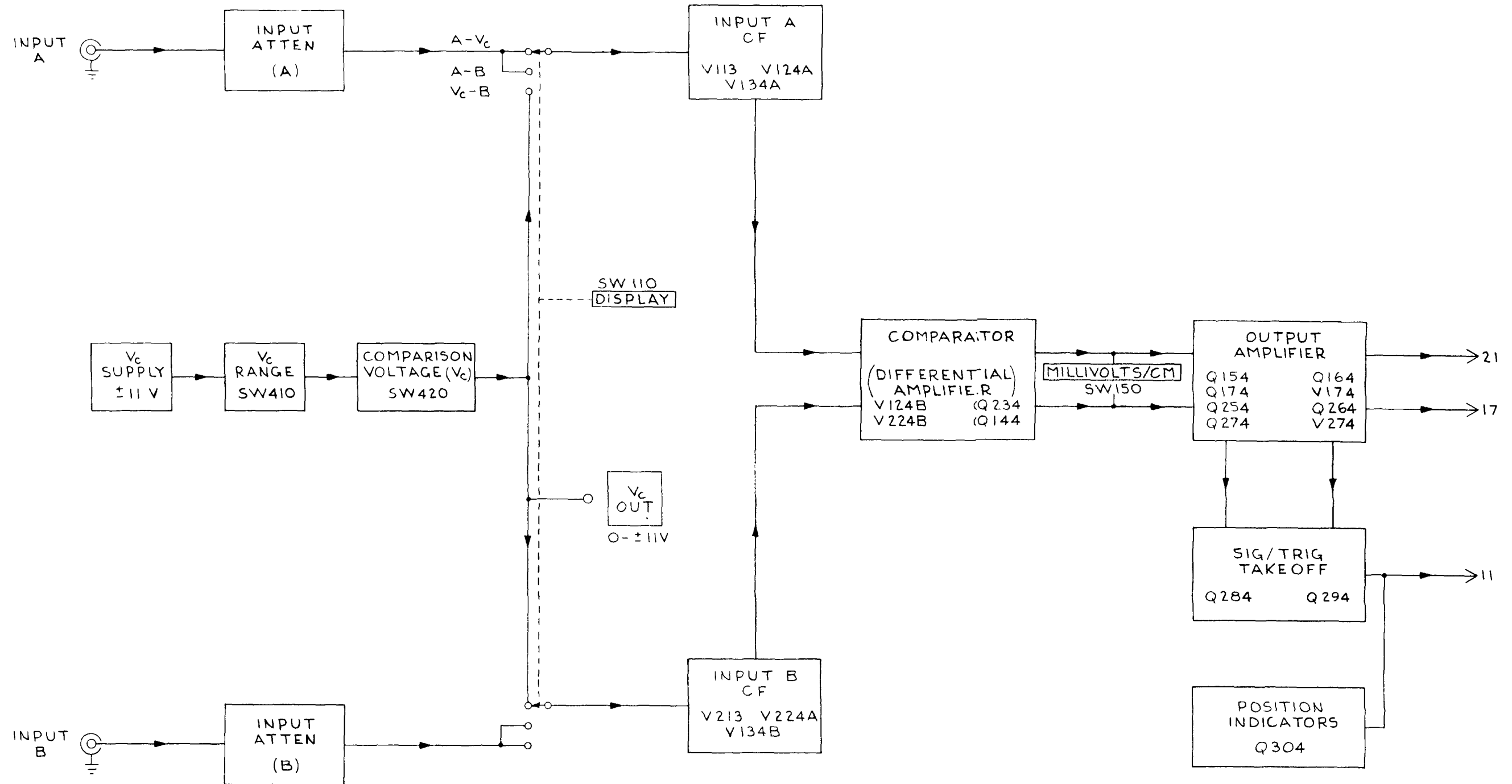

TYPE 3A7 PLUG IN

A

765
BLOCK DIAGRAM

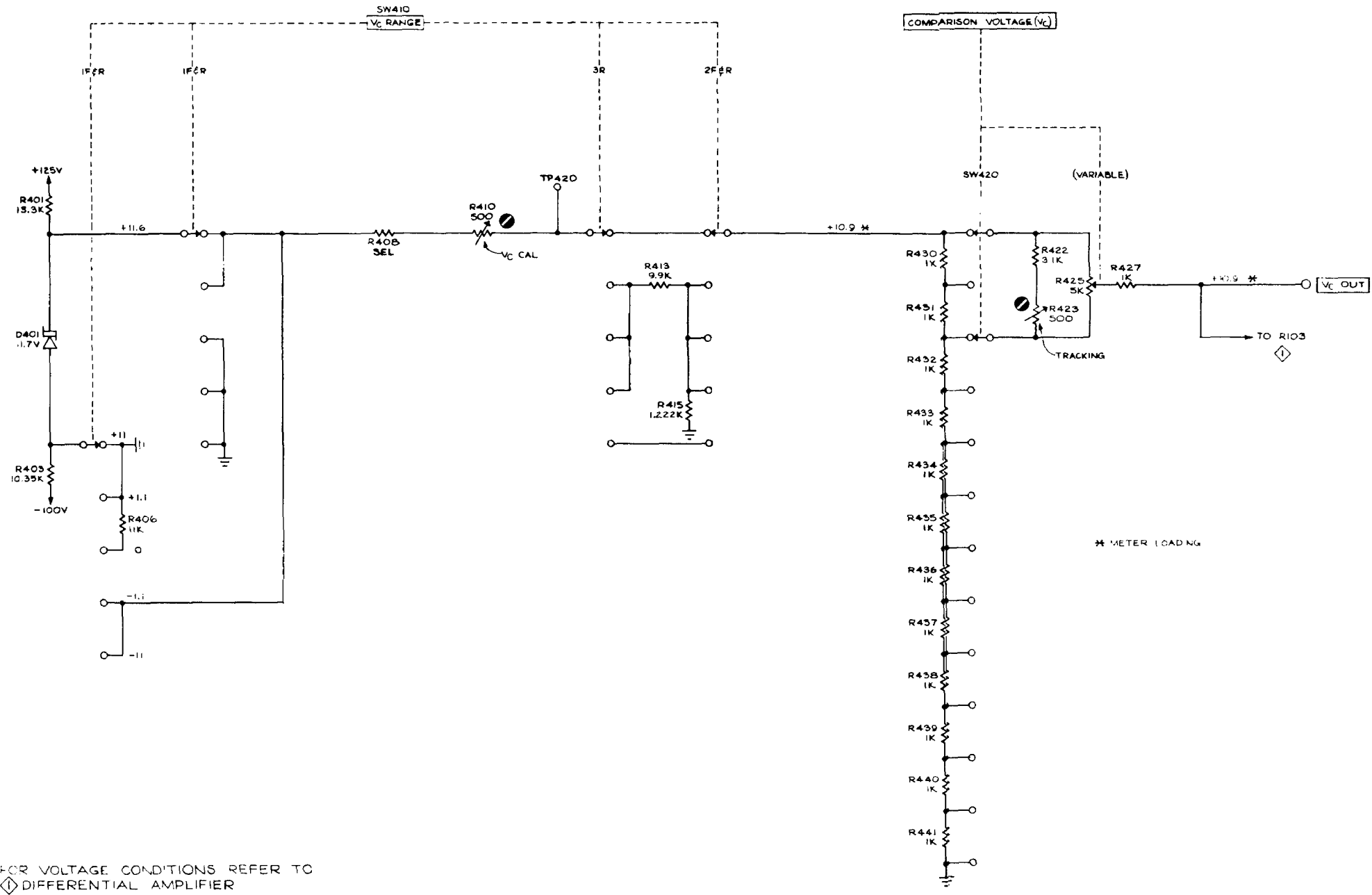

REFERENCE DIAGRAM
 ◇ DIFFERENTIAL AMPLIFIER

IMPORTANT:

Circuit voltages were obtained with a 20,000Ω/Volt dc VOM. All readings are in volts.

Voltage, waveform-amplitude and dc-level measurements are not absolute and may vary from unit to unit. To obtain these measurements, a 30-inch flexible-cable extension (012-0066-00) was used to operate the Type 3A7 out of the oscilloscope plug-in compartment.

Actual waveform photographs are shown on the schematic diagram. To show the waveforms in a time-related sequence, the test oscilloscope used for signal tracing was set for + Ext triggering on the 2-volt reference signal applied to Input A of the Type 3A7. Refer to the Maintenance section for full details about signal tracing.

VOLTAGES AND WAVEFORMS were obtained under these conditions:

Vc Range	+ 11
COMPARISON VOLTAGE	11 (10-10-0)
AC-DC-GND (Input A)	GND (for voltages) DC (for waveforms)
AC-DC-GND (Input B)	GND
INPUT ATTEN	10
DISPLAY	A-B
MILLIVOLTS/DIV	50
VARIABLE	CAL
POSITION	Centered

Signal - 2-volt 1-KHz calibrator signal applied to Type 3A7 input A connector and test oscilloscope + Ext connector.

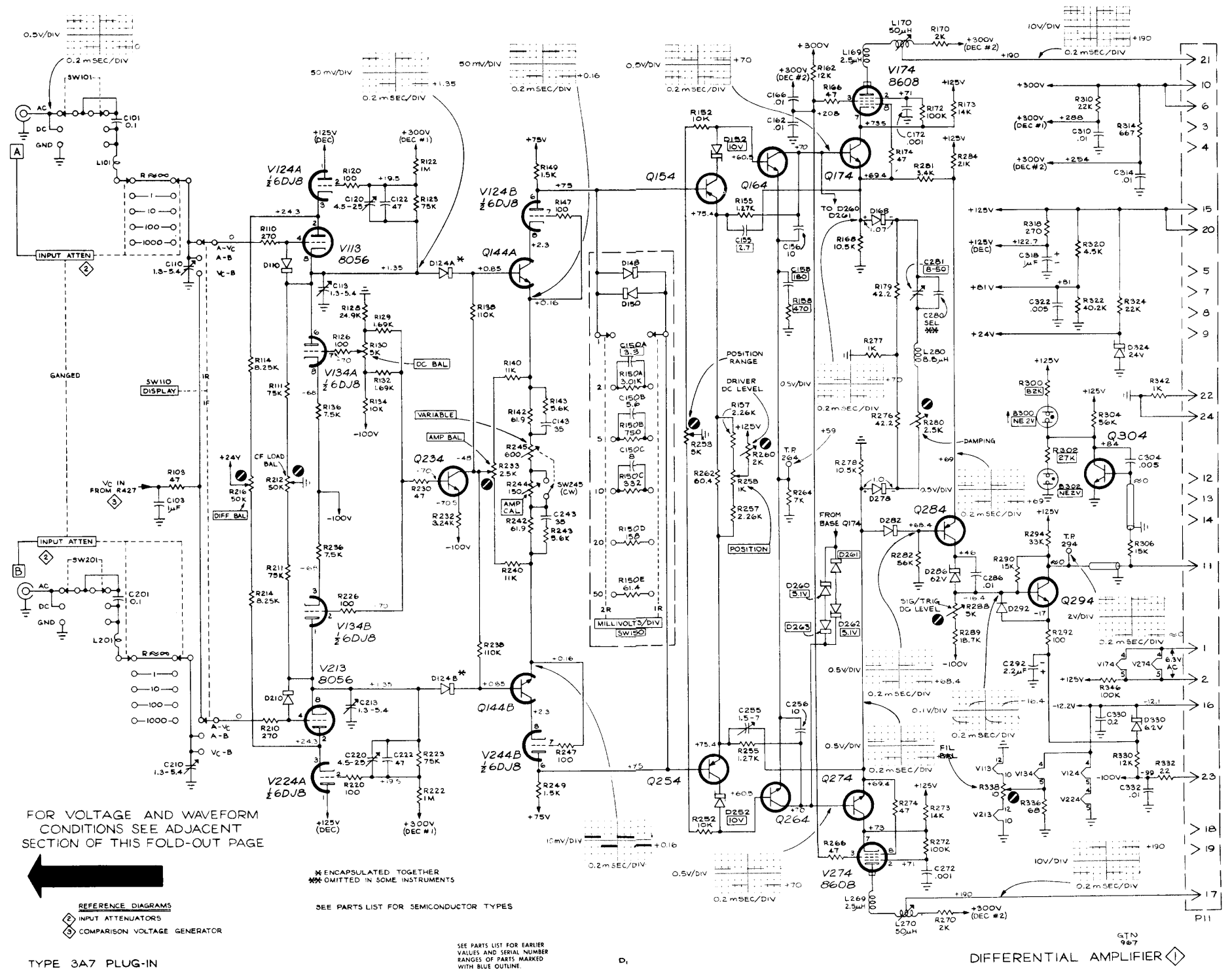

CROSS REFERENCE INDEX
FOR
TEKTRONIX, INC. TYPE 3A7 INSTRUCTION MANUAL

FEDERAL MANUFACTURERS CODE

TO

NAME AND ADDRESS

<u>CODE</u>	<u>NAME AND ADDRESS</u>
00779	AMP, Inc. Harrisburg, Pa.
00866	GOE Engineering Co. Los Angeles, Calif.
01121	Allen-Bradley Co. Milwaukee, Wisc.
01686	RCL Electronics, Inc. Manchester, N. H.
02660	Amphenol Corp. Broadview, Ill.
02735	Radio Corp. of America Solid State and Receiving Tube Division Somerville, N. J.
03877	Transitron Electronic Corp. Wakefield, Mass.
04713	Motorola Semiconductor Products, Inc. Phoenix, Ariz.
05129	Kilo Engineering Co. La Verne, Calif.
06751	Components Inc. Arizona Division Phoenix, Ariz.
07910	Continental Device Corp. Hawthorne, Calif.
08806	General Electric Co. Miniature Lamp Dept. Cleveland, Ohio
11237	Chicago Telephone of California, Inc. South Pasadena, Calif.
12327	Freeway Washer and Stamping Co. Cleveland, Ohio
12697	Clarostat Mfg. Co., Inc. Dover, N. H.

<u>CODE</u>	<u>NAME AND ADDRESS</u>
13715	Fairchild Camera and Instrument Corp. Semiconductor Division, Diode Plant San Rafael, Calif.
17870	Daven Division Thomas A. Edison Industries, McGraw Edison Co. Manchester, N.H.
20859	Mellowes Co., The Milwaukee, Wis.
24248	South Chester Corp. Southco Division Lester, Pa.
52676	S.K.F. Industries, Inc. Philadelphia, Pa.
56289	Sprague Electric Co. North Adams, Mass.
63743	Ward Leonard Electric Co. Mount Vernon, N.Y.
70276	Allen Mfg. Co. Hartford, Conn.
71590	Globe Union. Inc. Centralab Division Milwaukee, Wisc.
71785	Cinch Mfg. Co., and Howard B. Jones Div. Chicago, Ill.
72982	Erie Technological Products, Inc. Erie, Pa.
73138	Beckman Instruments, Inc. Helipot Division Fullerton, Calif.
73445	Amperex Electronic Co. Hicksville, N.Y.
73743	Fischer Special Mfg. Co. Cincinnati, Ohio
74445	Holo-Krome Co. Hartford, Conn.
74970	Johnson, E.F., Co. Waseca, Minn.

<u>CODE</u>	<u>NAME AND ADDRESS</u>
75042	IRC Division of TRW, Inc. Philadelphia, Pa.
76854	Oak Mfg. Co. Division of Oak Electro/Netics Corp. Crystal Lake, Illinois
77250	Pheoll Manufacturing Division of Allied Products Corp. Chicago, Ill.
78189	Illinois Tool Works, Inc. Shakeproof Division Elgin, Ill.
78471	Tilley Mfg. Co. San Francisco, Calif.
78488	Stackpole Carbon Co. St. Marys, Pa.
79136	Waldes, Kohinoor, Inc. Long Island City, N.Y.
79807	Wrought Washer Mfg. Co. Milwaukee, Wis.
80009	Tektronix, Inc. Beaverton, Oreg.
81483	International Rectifier Corp. El Segundo, Calif.
83385	Central Screw Co. Chicago, Ill.
88245	Litton Industries USECO Division Van Nuys, Calif.
89663	Reese, J. Ramsey, Inc. New York, N.Y.
91662	Elco Corp. Willow Grove, Pa.
99378	Atlee Corp. Winchester, Mass.

NOTES

The following parts do not have a bona-fide twenty-digit part number. These parts can be ordered by description from any acceptable manufacturer.

<u>NOTE NUMBER</u>	<u>TEKTRONIX PART NO.</u>	<u>DESCRIPTION (Ordering Information)</u>
005	210-0017-00	Steel, No. 5 ASA medium split spring, bright cadmium plating, clear chromate conversion coating.
011	210-0801-00	Steel, 0.140 ± 0.010 in. ID x 0.281 ± 0.010 in. OD x 0.025 ± 0.003 in. thick, bright cadmium plating, clear chromate conversion coating.
024	210-0870-00	Steel, 0.147 in. ID x 0.321 in. OD x 0.035 in. thick, bright cadmium plating, clear chromate conversion coating.
035	211-0007-00	Steel, binding (undercut) head, 4-40 UNC-2A x 3/16 in., slot drive, bright cadmium plating, clear chromate conversion coating.
036	211-0008-00	Steel, binding (undercut) head, 4-40 UNC-2A x 1/4 in., slot drive, bright cadmium plating, clear chromate conversion coating.
039	211-0013-00	Steel, round head, 4-40 UNC-2A x 3/8 in., slot drive, bright cadmium plating, clear chromate conversion coating.
045	211-0019-00	Steel, round head, 4-40 UNC-2A x 1 in., slot drive, bright cadmium plating, clear chromate conversion coating.
060	211-0504-00	Steel, binding (undercut) head, 6-32 UNC-2A x 1/4 in., slot drive, bright cadmium plating, clear chromate conversion coating.
062	211-0507-00	Steel, binding (undercut) head, 6-32 UNC-2A x 5/16 in., slot drive, bright cadmium plating, clear chromate conversion coating.
070	211-0516-00	Steel, binding (undercut) head, 6-32 UNC-2A x 7/8 in., slot drive, bright cadmium plating, clear chromate conversion coating.
088	211-0544-00	Steel, truss head, 6-32 UNC-2A x 3/4 in., cross recess Type 1, bright cadmium plating, clear chromate conversion coating.

NOTE NUMBER	TEKTRONIX PART NO.	DESCRIPTION (Ordering Information)
112	212-0044-00	Steel, round head, 8-32 UNC-2A x 1/2 in., cross recess Type 1, bright cadmium plating, clear chromate conversion coating.
128	213-0020-00	Steel, hex socket, 6-32 UNC-2A x 1/8 in., cup point, bright cadmium plating, clear conversion coating.
131	213-0048-00	Steel, hex socket, 4-40 UNC-3A x 1/8 in., cup point, bright cadmium plating, clear conversion coating.
163	213-0005-00	Steel, hex socket, 8-32 UNC-3A x 1/8 in., cup point, bright cadmium plating, clear conversion coating.
211	210-0940-00	Steel, 0.250 in. ID x 0.375 in. OD, ± 0.005 in. x 0.020 in. thick ± 0.001 , bright cadmium plated, clear chromate conversion coating.
238	211-0089-00	Steel, round head, 2-56 UNC-2A x 3/8 in. cross recess Type 1, bright black finish.
240	210-0586-00	Steel, 4-40 UNC-2B x 0.25 in. across flats x 0.0937 in. thick, Style 841, cadmium plated, clear chromate conversion coating.
253	213-0004-00	Steel, hex socket, 6-32 UNC-3A x 3/16 in., cup point, bright cadmium plating, clear conversion coating.
255	213-0055-00	Steel, pan head, 2-32 x 3/16 in., cross recess Type 1, thread forming Type B, bright cadmium plated, clear chromate conversion coating.
256	213-0075-00	Steel, hex socket, 4-40 UNC-3A x 3/32 in., cup point, bright cadmium plating, clear chromate conversion coating.
272	213-0076-00	Steel, 2-56 UNC-3A x 1/8 in., hexagon socket, flat point, bright cadmium plating, clear conversion coating.
281	214-0274-00	Stainless Steel, 1/8 in. diameter Grade 100.
287	210-0913-00	Phenolic, 1/4 in. ID x 3/8 in. OD x 1/32 in. thick, grade CE.
291	210-0457-00	Steel, 6-32 UNC-2B x 0.312 in. across flats x 0.141 in. thick with integral external toothed lockwasher, bright cadmium plating with clear chromate conversion coating.

<u>NOTE NUMBER</u>	<u>TEKTRONIX PART NO.</u>	<u>DESCRIPTION (Ordering Information)</u>
293	211-0094-00	Stainless steel, truss head, cross recess Type 1, 4-40 UNC-2A x 0.500 in., passivated.
296	211-0097-00	Steel, pan head, cross recess Type 1, 4-40 UNC-2A x 5/16 in., bright cadmium plating, clear chromate conversion coating.
387	213-0044-00	Steel, No. 4 pan head, 5-32 x 3/16 in., Pozidriv, Type C, bright cadmium plated, clear chromate conversion coating.

<u>TEKTRONIX, INC. PART NO.</u>	<u>MFR CODE NO.</u>	<u>MFR PART NO.</u>	<u>FEDERAL STOCK NUMBER</u>
108-0057-00	80009	108-0057-00	
108-0148-00	80009	108-0148-00	
108-0270-00	80009	108-0270-00	5915-900-1105
108-0271-00	80009	108-0271-00	5915-018-1281
108-0298-00	80009	108-0298-00	5915-849-9419
108-0332-00	80009	108-0332-00	5915-018-1382
114-0190-00	80009	114-0190-00	
124-0087-00	80009	124-0087-00	6625-677-9002
124-0145-00	80009	124-0145-00	5940-937-0882
124-0147-00	80009	124-0147-00	5940-937-0884
124-0148-00	80009	124-0148-00	5940-937-0886
129-0006-00	00866	1700P	
129-0053-00	80009	129-0053-00	5940-794-3294
131-0149-00	02660	26-159-24	5935-258-2974
131-0374-00	00779	66143-3	
136-0014-00	91662	04-901-03	5935-577-0239
136-0022-00	91662	04-915-13	5935-856-3713
136-0078-00	91662	05-0704-010	
136-0098-00	74970	105-803	
136-0174-00	71785	149-19-11-070	
136-0181-00	80009	136-0181-00	5935-918-0469
136-0188-00	71785	133-65-91-034	
150-0030-00	08806	A2BT	
151-0096-00	02735	34663	5960-759-9393
151-0103-00	04713	SM1307	5960-755-1812
151-0108-00	04713	SM1527	5960-759-9392
151-0133-00	04713	SM3155	5961-931-8251

<u>TEKTRONIX, INC. PART NO.</u>	<u>MFR CODE NO.</u>	<u>MFR PART NO.</u>	<u>FEDERAL STOCK NUMBER</u>
151-0136-00	02735	35495	
151-0139-00	13715	SP9843	5961-931-8256
152-0008-00	03877	T12G	5960-856-8642
152-0149-00	04713	1N961B	
152-0153-00	13715	FD7003	5960-923-9773
152-0165-00	80009	152-0165-00	
152-0166-00	81483	69-9035	
152-0171-00	06751	53903	
152-0178-00	80009	152-0178-00	
152-0185-00	07910	CD8204	5961-936-7604
152-0195-00	81483	IR69-6512	
152-0265-00	04713	1N970B	
152-0285-00	04713	1N980B	
154-0187-00	73445	6DJ8ECC88	5960-679-0016
154-0491-00	73445	8608	
157-0099-00	80009	157-0099-00	
166-0106-00	76854	8980	
179-1000-00	80009	179-1000-00	
200-0554-00	80009	200-0554-00	
200-0588-00	80009	200-0588-00	
200-0589-00	80009	200-0589-00	
200-0593-00	80009	200-0593-00	
200-0642-00	99378	101-334-3	
200-0643-00	80009	200-0643-00	
210-0001-00	83385	10200-11	
210-0004-00	78189	1204-00-00-0541C	5310-846-4613
210-0012-00	78189	1220-02-00-0541C	

<u>TEKTRONIX, INC. PART NO.</u>	<u>MFR CODE NO.</u>	<u>MFR PART NO.</u>	<u>FEDERAL STOCK NUMBER</u>
210-0013-00	78189	1220-00-00-0541C	5310-861-5809
210-0017-00	20859	NOTE005	
210-0046-00	78189	1214-05-00-0541C	
210-0047-00	78189	1234-04-00-0541C	
210-0049-00	78189	1228-02-00-0541C	
210-0201-00	78189	2104-04-00-2520N	5940-156-7341
210-0202-00	78189	2104-06-00-2520N	5940-050-7009
210-0204-00	78189	2157-06-01-2520N	5940-238-9597
210-0207-00	12697	01136902	5940-893-7369
210-0405-00	73743	2X12157-402	
210-0406-00	73743	2X12161-402	5310-847-1337
210-0407-00	73743	3038-0228-402	5310-894-4638
210-0413-00	73743	3145-402	5310-576-7214
210-0429-00	80009	210-0429-00	5310-710-0799
210-0455-00	73743	3089-402	
210-0457-00	83385	NOTE291	5310-893-5972
210-0465-00	73743	3095-402	
210-0478-00	80009	210-0478-00	5340-649-8429
210-0568-00	80009	210-0568-00	
210-0583-00	73743	2X20319-402	
210-0586-00	78189	NOTE240	4931-L00-1979
210-0801-00	12327	NOTE011	
210-0840-00	89663	644-R	5310-275-0650
210-0870-00	12327	NOTE024	5310-826-1114
210-0913-00	78471	NOTE287	
210-0940-00	79807	NOTE211	
210-0951-00	80009	210-0951-00	

<u>TEKTRONIX, INC. PART NO.</u>	<u>MFR CODE NO.</u>	<u>MFR PART NO.</u>	<u>FEDERAL STOCK NUMBER</u>
211-0007-00	83385	NOTE035	5305-899-7867
211-0008-00	83385	NOTE036	5305-861-5761
211-0013-00	83385	NOTE039	
211-0019-00	83385	NOTE045	
211-0089-00	77250	NOTE238	
211-0094-00	83385	NOTE293	
211-0097-00	83385	NOTE296	
211-0504-00	83385	NOTE060	
211-0507-00	83385	NOTE062	5305-638-0557
211-0516-00	83385	NOTE070	
211-0544-00	83385	NOTE088	
212-0044-00	83385	NOTE112	
213-0004-00	74445	NOTE253	5305-841-8014
213-0005-00	74445	NOTE163	
213-0020-00	70276	NOTE128	5305-893-7199
213-0044-00	83385	NOTE387	5305-957-7630
213-0048-00	74445	NOTE131	5305-952-0172
213-0055-00	83385	NOTE255	
213-0075-00	70276	NOTE256	
213-0076-00	74445	NOTE272	
214-0052-00	24248	43-99-125-41	
214-0240-00	80009	214-0240-00	
214-0274-00	52676	NOTE281	
214-0276-00	80009	214-0276-00	
214-0321-00	80009	214-0321-00	
214-0456-00	80009	214-0456-00	5910-072-8089
214-0461-00	80009	214-0461-00	

<u>TEKTRONIX, INC. PART NO.</u>	<u>MFR CODE NO.</u>	<u>MFR PART NO.</u>	<u>FEDERAL STOCK NUMBER</u>
214-0948-00	80009	214-0948-00	
220-0440-00	80009	220-0440-00	
220-0441-00	80009	220-0441-00	
260-0603-00	80009	260-0603-00	
260-0633-00	80009	260-0633-00	5930-018-1289
260-0634-00	80009	260-0634-00	5930-018-1290
260-0635-00	80009	260-0635-00	5930-018-1291
260-0712-00	76854	251233GK1REVA	
260-0713-00	76854	PA600-444REVC	
262-0679-00	80009	262-0679-00	
262-0680-01	80009	262-0680-01	
262-0732-00	80009	262-0732-00	
262-0733-00	80009	262-0733-00	
262-0734-01	80009	262-0734-01	
276-0507-00	78488	57-0180-7D	6625-082-7547
281-0005-00	72982	503-000C0P010R	5910-126-1618
281-0010-00	72982	503-000C0P037R	5910-126-1619
281-0022-00	72982	557-019U2P034R	5910-768-8455
281-0077-00	74970	189-2-5	
281-0098-00	74970	189-1-4	5910-065-9822
281-0099-00	74970	189-2-4	
281-0102-00	74970	189-5-4	
281-0103-00	74970	189-6-4	
281-0503-00	72982	301-000C0H0809D	5910-713-1986
281-0504-00	72982	301-000C0G0100F	5910-713-1941
281-0519-00	72982	308-000C0G0470K	5910-801-3866
281-0534-00	72982	301-000C0J0339C	5910-766-3925

<u>TEKTRONIX, INC. PART NO.</u>	<u>MFR CODE NO.</u>	<u>MFR PART NO.</u>	<u>FEDERAL STOCK NUMBER</u>
281-0544-00	72982	301-000C0H0569D	5910-850-0974
281-0547-00	72982	301-000C0J0279C	
281-0613-00	72982	374-001C0G0100F	
281-0625-00	56289	308-000-C0G0-350J	
283-0000-00	72982	831Z5U102P	5910-688-8702
283-0001-00	72982	851Z5U0502P	5910-615-0406
283-0002-00	72982	811Z5U0103Z	5910-721-2030
283-0026-00	56289	5C2A	5910-954-9055
283-0059-00	56289	5C13A10	5910-932-7113
283-0103-00	56289	40C393A1	5910-916-8009
283-0108-00	56289	3C2219BH3	
283-0109-00	56289	20C151A3	
283-0607-00	72982	654-00618A0202K	
290-0136-00	72982	900-500B0E0225M	
290-0164-00	56289	30D105F150BA4	
290-0094-00	80009	295-0094-00	5910-018-1292
301-0113-00	01121	EB1135	
301-0563-00	01121	EB5635	5905-171-1986
302-0102-00	01121	EB1021	5905-195-6817
302-0104-00	01121	EB1041	5905-192-3987
302-0273-00	01121	EB2731	5905-279-3499
302-0563-00	01121	EB5631	5905-171-1986
302-0823-00	01121	EB8231	5905-279-3494
303-0123-00	01121	GB1235	
303-0223-00	01121	GB2235	5905-299-2022
303-0333-00	01121	GB3335	5905-102-2740
303-0680-00	01121	GB6805	

<u>TEKTRONIX, INC. PART NO.</u>	<u>MFR CODE NO.</u>	<u>MFR PART NO.</u>	<u>FEDERAL STOCK NUMBER</u>
304-0102-00	01121	GB1021	
308-0107-00	63743	16743	
308-0271-00	63743	22747	
308-0301-00	63743	25271	
308-0316-00	17870	1195-312F	
308-0319-00	63743	25847	5905-111-6194
308-0323-00	17870	1350-102B	
308-0324-00	17870	1195-1222R20R01	
308-0326-00	17870	1195-992R01	
308-0334-00	01686	T2A7023	
308-0359-00	63743	28814	
308-0360-00	63743	28843	
308-0383-00	63743	29721	
310-0626-00	80009	310-0626-00	
311-0001-00	12697	CM10649	5905-807-4146
311-0074-00	71590	BA004-086	5905-980-9342
311-0091-00	01121	GW3083	5905-814-3972
311-0329-00	01121	GA2G024S503MA	
311-0360-00	73138	7216-394-0	
311-0443-00	01121	LA1G032S252MZ	
311-0474-00	11237	37193	
311-0475-00	11237	37194	
311-0482-00	12697	CM32426	
311-0484-00	73138	78LR500	
311-0485-00	01121	GA1G024S251UA	
311-0486-00	01121	GA1G024S501UA	
311-0487-00	01121	GA1G024S303UA	

<u>TEKTRONIX, INC. PART NO.</u>	<u>MFR CODE NO.</u>	<u>MFR PART NO.</u>	<u>FEDERAL STOCK NUMBER</u>
311-0496-00	01121	FR252M	
311-0497-00	01121	FR503M	
311-0566-00	71590	BA147-011	
311-0568-00	71590	BA826-036	
315-0271-00	01121	CB2715	5905-725-6995
315-0471-00	01121	CB4715	5905-683-2242
316-0101-00	01121	CB1011	5905-726-5340
316-0153-00	01121	CB1531	
316-0220-00	01121	CB2201	
316-0223-00	01121	CB2231	
316-0271-00	01121	CB2711	
316-0470-00	01121	CB4701	5905-721-0672
316-0562-00	01121	CB5621	
321-0061-00	75042	CEAT0-42R20F	
321-0076-00	75042	CEAT0-60R40F	
321-0077-00	75042	CEAT0-61R90F	
321-0193-00	75042	CEAT0-1001F	
321-0215-00	75042	CEAT0-1691F	
321-0389-00	75042	CEAT0-1103F	
321-0637-00	75042	CEAT2-9901D	
323-0116-00	75042	CECT0-1580F	
323-0147-00	75042	CECT0-3320F	
323-0203-00	75042	CECT0-1271F	
323-0210-00	75042	CECT0-1501F	
323-0227-00	75042	CECT0-2261	
323-0239-00	75042	CECT0-3011F	
323-0242-00	75042	CECT0-3241	

<u>TEKTRONIX, INC. PART NO.</u>	<u>MFR CODE NO.</u>	<u>MFR PART NO.</u>	<u>FEDERAL STOCK NUMBER</u>
323-0244-00	75042	CECT0-3401	
323-0277-00	75042	CECT0-7501	
323-0281-00	75042	CECT0-8251F	
323-0289-00	75042	CECT0-1002F	
323-0291-00	75042	CECT0-1052	
323-0293-00	75042	CECT0-1102	
323-0303-00	75042	CECT0-1402	
323-0306-00	75042	CECT0-1502F	
323-0315-00	75042	CECT0-1872F	
323-0320-00	75042	CECT0-2102F	
323-0327-00	75042	CECT0-2492F	
323-0347-00	75042	CECT0-4022F	
323-0373-00	75042	CECT0-7502F	
323-0481-00	75042	CECT0-1004F	
323-0623-00	75042	CECT0-9993F	
323-0647-00	75042	CECT0-61R40F	
323-0680-00	75042	CECT2-9883F	
323-0681-00	75042	CECT2-9903D	
325-0003-00	75042	MEAT5-9982B5PM	
325-0004-00	75042	MEBT9-9003BFPM	
331-0152-00	05129	471S52	
333-0910-00	80009	333-0910-00	
337-0008-00	71785	151-14-20-025	5960-264-3004
337-0670-00	80009	337-0670-00	
337-0671-00	80009	337-0671-00	
337-0759-00	80009	337-0759-00	
337-0761-01	80009	337-0761-01	

<u>TEKTRONIX, INC. PART NO.</u>	<u>MFR CODE NO.</u>	<u>MFR PART NO.</u>	<u>FEDERAL STOCK NUMBER</u>
337-0788-00	80009	337-0788-00	
343-0089-00	80009	343-0089-00	
344-0105-00	80009	344-0105-00	
348-0031-00	80009	348-0031-00	5325-071-6256
348-0056-00	80009	348-0056-00	5325-937-2211
348-0086-00	80009	348-0086-00	
351-0037-00	80009	351-0037-00	5895-975-6783
352-0084-00	80009	352-0084-00	
354-0179-00	80009	354-0179-00	
354-0184-00	79136	5555-25	
354-0219-00	79136	5103-25-MD-R	
354-0234-00	80009	354-0234-00	5961-020-9131
354-0251-00	80009	354-0251-00	
355-0046-00	80009	355-0046-00	
355-0507-00	80009	355-0507-00	
358-0010-00	80009	358-0010-00	5355-711-3612
358-0054-00	80009	358-0054-00	4730-082-5833
358-0136-00	88245	420971	
358-0215-00	80009	358-0215-00	
358-0216-00	80009	358-0216-00	5355-016-8665
361-0009-00	80009	361-0009-00	5340-792-2001
366-0031-00	80009	366-0031-00	5355-685-5580
366-0109-00	80009	366-0109-00	5355-983-8412
366-0142-00	80009	366-0142-00	
366-0173-00	80009	366-0173-00	5355-932-7029
366-0175-00	80009	366-0175-00	5355-923-5660
366-0189-00	80009	366-0189-00	5355-064-0133

<u>TEKTRONIX, INC. PART NO.</u>	<u>MFR CODE NO.</u>	<u>MFR PART NO.</u>	<u>FEDERAL STOCK NUMBER</u>
366-0225-00	80009	366-0225-00	5355-882-1194
366-0274-00	80009	366-0274-00	5355-858-8272
366-0324-00	80009	366-0324-00	
366-0341-00	80009	366-0341-00	
376-0014-00	76854	22675-001	6625-708-7198
376-0048-00	80009	376-0048-00	
376-0051-00	80009	376-0051-00	
377-0103-00	80009	377-0103-00	
378-0541-00	80009	378-0541-00	6210-103-6337
384-0325-00	80009	384-0325-00	
384-0361-00	80009	384-0361-00	
384-0362-00	80009	384-0362-00	
384-0364-00	80009	384-0364-00	
384-0365-00	80009	384-0365-00	
384-0615-00	80009	384-0615-00	
386-0214-00	80009	386-0214-00	
386-0215-00	80009	386-0215-00	
386-0216-00	80009	386-0216-00	
387-0985-00	80009	387-0985-00	
407-0163-00	80009	407-0163-00	
407-0164-00	80009	407-0164-00	
426-0289-00	80009	426-0289-00	
441-0586-00	80009	441-0586-00	
441-0634-00	80009	441-0634-00	
610-0130-00	80009	610-0130-00	
644-0009-01	80009	644-0009-01	

SECTION 9 PREVENTIVE MAINTENANCE INSTRUCTIONS

1. Scope of Maintenance

The maintenance duties assigned to the operator and organizational repairman of this equipment are listed below with a reference to the paragraphs covering the specific maintenance functions. The preventive maintenance procedures require no special tools or test equipment.

- a. Daily preventive maintenance checks and services (paragraph 5 below).
- b. Weekly preventive maintenance checks and services (paragraph 6 below).
- c. Monthly preventive maintenance checks and service (paragraph 7 below).
- d. Quarterly preventive maintenance checks and services (paragraph 9 below).
- e. Cleaning (paragraph 11 below).
- f. Touchup painting instructions (paragraph 12 below).

2. Materials Required For Maintenance

- a. Trichloroethane (Federal stock No. 6810-292-9625).

WARNING

The fumes of trichloroethane are toxic. Provide thorough ventilation whenever used. Do not use near an open flame. Trichloroethane is not flammable, but exposure of the fumes to an open flame converts the fumes to highly toxic, dangerous gases.

- b. Cleaning cloth.
- c. Fine sandpaper.
- d. Touchup paint.

3. Preventive Maintenance

Preventive maintenance is the systematic care, servicing, and inspection of equipment to prevent the occurrence of trouble, to reduce downtime, and to insure that the equipment is serviceable.

a. Systematic Care. The procedure given in paragraphs 3 through 12 below covers routine systematic care and cleaning essential to proper upkeep and operation of the equipment

b. Preventive Maintenance Checks and Services. The maintenance checks and services charts outline functions to be performed at specific intervals. These checks and services are to maintain equipment in a combat serviceable condition; that is, in good general (physical) condition and in good operating condition. To assist operators in maintaining combat serviceability, the charts indicate what to check, how to check, and the normal indications. The reference column lists the paragraphs and other publications that contain additional information. If the defect cannot be found by performing the corrective action indicated a higher category of maintenance or repair is required. Records and reports of these checks and services must be made in accordance with the requirements in TM 38-750.

4. Preventive Maintenance Checks and Services Periods

Preventive maintenance checks and services of this equipment are required weekly, monthly, and quarterly. Daily maintenance checks and services are specified in paragraph 5 below. Paragraph 6 below specifies checks and services that must be performed weekly. If the equipment is maintained in a standby condition, the daily and weekly checks should be accomplished at the same time. The maintenance checks and services that are accomplished monthly are specified in paragraph 7 below. Quarterly maintenance checks and services are specified in paragraph 9 below.

5. Daily Preventive Maintenance Checks and Services Chart

<i>Sequence No.</i>	<i>Items to be inspected.</i>	<i>Procedure</i>	<i>Reference</i>
1	Completeness	See that the equipment is complete.	Appendix B
2	Cleanliness	Exterior of equipment must be clean and dry, free of fungus, dirt, dust and grease.	Paragraph 11 below
3	Operational Check.	Check the operational efficiency.	
4	Controls	See that controls operate smoothly and are fastened in place securely.	

6. Weekly Preventive Maintenance and Services Chart

<i>Sequence No.</i>	<i>Items to be inspected.</i>	<i>Procedure</i>	<i>Reference</i>
1	Components	Inspect cards and cables for chafed, cracked, and frayed insulation. Replace connectors that are broken, stripped, or worn.	Paragraphs 11 and 12 below.
2	Metal surfaces.	Inspect exposed metal surface - for rust and corrosion. Clean and touch up with paint as required.	

7. Monthly Maintenance

Perform the maintenance functions indicated in the monthly preventive maintenance checks and services

chart (paragraph 8 below) once each month. Periodic daily (paragraph 5 above) and weekly (paragraph 6 above) services constitute a part of the monthly checks.

8. Monthly Preventive Maintenance Checks and Services Chart

<i>Sequence No</i>	<i>Item to be inspected.</i>	<i>Procedure</i>
1	Terminations	Inspect for loose connections and cracked or broken insulation.
2	Control panel	Clean panel thoroughly and check all surfaces for chips, cracks, and abnormal wear.
3	Hardware	Inspect all hardware for possible damage.

9. Quarterly Maintenance

Quarterly preventive maintenance checks and services are required for this equipment. Periodic daily, weekly, and monthly services constitute a part of the quarterly preventive maintenance checks and services and must be performed in sequence. All deficiencies and

shortcomings will be recorded in accordance with the requirements of TM 38-750. Perform all the checks and services listed in the quarterly preventive maintenance checks and services chart (paragraph 10 below) in the sequence listed. Adjustment of the maintenance interval must be made to compensate for any unusual operating conditions.

10. Quarterly Preventive Maintenance Checks and Services Chart

<i>Sequence No.</i>	<i>Items to be inspected.</i>	<i>Procedure</i>	<i>Reference</i>
1	Publications	See that all publications are complete, serviceable, and current.	DA Pam 310-4
2	Modifications	Check DA Pam 310-7 to determine whether new applicable MWO's have been published. All URGENT MWO's must be applied immediately. All NORMAL MWO's must be scheduled.	TM 38-750 and DA Pain 310-7.

11. Cleaning

Inspect the exterior surfaces. The surfaces must be free of dust, dirt, grease, and fungus.

- a. Remove dust and loose dirt with a clean, soft cloth.
- b. Remove grease, fungus, and ground-in dirt. Use a damp cloth (not wet) with trichloroethane to clean terminations. If dirt on the body of the unit is difficult to remove, use mild soap and water.

- c. Remove dust or dirt from the jacks and plugs with a brush.

12. Touchup Painting Instructions

Remove dust and corrosion from metal surfaces by lightly sanding them with fine sandpaper. Brush two thin coats of paint on the bare metal to protect it from further corrosion. Refer to applicable cleaning and refinishing practices specified in TB 746-10.

APPENDIX A**REFERENCES**

Following is a list of publications available to Differential Comparator, Tektronix Type 3A7 operator and maintenance personnel.

DA PAM 310-4	Index of Technical Manuals, Technical Bulletins, Supply Manuals (types 7, 8, and 9), Supply Bulletins, and Lubrication Orders.
DA PAM 310-7	U S Army Equipment Index of Modification Work Orders.
TM 38-750	The Army Maintenance Management System (TAMMS)
SB 38-100	Preservation, Packaging, Packing, and Marking Materials, Supplies, and Equipment used by the Army.
TB 746-10	Field Instructions for Painting and Preserving Electronics Command Equipment.
TB 750-236	Calibration Requirements for the Maintenance of Army Materiel.

APPENDIX B
BASIC ISSUE ITEMS LIST AND
ITEMS TROOP INSTALLED OR AUTHORIZED LIST

(Not Applicable)

APPENDIX C

MAINTENANCE ALLOCATION CHART

Nomenclature of end item or component

DIFFERENTIAL COMPARATOR, MIS-10285

This Maintenance Allocation Chart designates overall responsibility for the performance of maintenance functions on the identified end item or component. The implementation of field maintenance tasks upon this end item or component will be consistent with the assigned maintenance operations which are defined as follows:

<i>Operation</i>	<i>Definition</i>
Depot	That level of logistics which has the facilities, personnel, and capabilities to equal the quality of the equipment repair available at the contractor's facilities (D).
Reference	That level in the maintenance of calibration equipment which provides DS and GS logistical support (H).
Transfer	That level in the maintenance of calibration equipment which provides organizational and limited DS logistical support to secondary transfer equipment (F).

DIFFERENTIAL COMPARATOR

CHART NUMBER MIS - 10285

MAC

Group Number	Functional Group	Maintenance Function												
		a	b	c	d	e	f	g	h	i	j	k	l	m
		Inspect	Test	Service	Adjust	Align	Calibrate	Install	Replace	Repair	Overhaul	Rebuild	Tool Reqcd.	Remarks
1	DIFFERENTIAL COMPARATOR UNIT	F	H	F			H	F	F	H	D		all	A

**DIFFERENTIAL COMPARATOR
CHART NUMBER MIS-10285
TOOLS REQUIRED**

Tool Code	Category	Nomenclature	Tool Number
1-b, f, i, j	H	CAPACITANCE STANDARD, Variable	8579475
	H	DIVIDER, Voltage	MIS-10295
	H	GENERATOR, Signal	8616377
	H	GENERATOR, Square wave	MIS-10284
	H	MULTIMETER	7910902
	H	OSCILLATOR, Audio-Radio frequency	MIS-10224
	H	OSCILLOSCOPE	7910655-2
	H	TIME BASE UNIT - Plug-In	7912040-1
	H	RESISTOR, Decade	7907234
	H	VOLTAGE MEASUREMENT SYSTEM	MIS-10216
	H	ADAPTER CONNECTOR	MS 35173274
	H	ADAPTER CONNECTOR	7907517
	H	ADAPTER CONNECTOR	7907560
	F	ADAPTER CONNECTOR	7909401
	F	ADAPTER CONNECTOR	10519439
	H	CABLE ASSEMBLY, Radio frequency	7907467
H	H	CABLE ASSEMBLY, Radio frequency 2 ea	7907471
	H	CAPACITOR STD, Fixed	7910380
	H	EXTENSION, Flexible	7911755
	H	LEAD, Electrical 4 ea	7907497
	H	LEAD, Electrical 4 ea	7907498
1-c	F	CLEANER, Electrical contact	6850-973-3122
	F	BRUSH, Artist	8020-224-8022
	F	BRUSH, Dusting	7920-685-3980
	F	CLEAN SOFT CLOTH	7920-205-3571
1-i, j	H	TOOL KIT, Alignment, electricians	5180-650-7821

**DIFFERENTIAL COMPARATOR
CHART NUMBER MIS-10285
REMARKS**

Remarks Code	Remarks
A-b	Test in accordance with Section II of calibration procedure TB 9-6625-1897-50.
A-c	Clean components and case periodically.
A-f	Calibrate in accordance with Section II of calibration procedure, TB 9-6625-1897-50.
A-i	Solder all connections per MIL-S-45743.
A-j	Solder all connections per MIL-S-45743.

By Order of the Secretary of the Army:

Official:

W.C. WESTMORELAND,
General, United States Army,
Chief of Staff

VERNE L. BOWERS,
Major General, United States Army,
The Adjutant General.

Distribution:

To be distributed in accordance with DA Form 12-34, Section II (qty rqr block No. 75) Requirements for Calibration Procedures Publications.

* U.S. GOVERNMENT PRINTING OFFICE - 1979/640-042/1524

